

Wave Wire Senso Wire

MOTORE TUBOLARE CON REGOLAZIONE MANUALE
DEL FINECORSO ELETTRONICO PER
SCREEN E TENDE A RULLO

I

TUBULAR MOTOR WITH MANUAL ADJUSTMENT
OF THE ELECTRONIC LIMIT SWITCH FOR
SCREEN AND ROLLER BLINDS

GB

ROHRMOTOR MIT MANUELLER EINSTELLUNG
DER ELEKTRONISCHEN ENDLAGEN ZU
SCREENS UND SENKRECHTMARKISEN

D

MOTEUR TUBULAIRE AVEC RÉGLAGE MANUEL
DES FINS DE COURSE ÉLECTRONIQUES
POUR SCREEN ET STORES VERTICAUX

F

MOTOR TUBULAR CON REGULACIÓN MANUAL
DEL FIN DE CARRERA ELECTRONICO
PARA TOLDOS VERTICALES Y SCREEN

E



Table of contents:

Electrical connections	p. 13
How to prepare the motor	p. 14
Key to symbols	p. 15
Command sequences example	p. 15
Limit switch setting	p. 16
Procedure for limit switch setting	p. 16
Example 1: Setting the upper limit switch as first position	p. 16
Example 2: Setting the lower limit switch as first position	p. 17
Changing limit switches.....	p. 18
Deleting of single limit switch positions	p. 18
Deleting of all limit switch positions	p. 18
Activation and adjustment of the super-sensitivity	p. 19
Deactivation super-sensitivity function	p. 19
Limit switches and obstacle detection	p. 20
Restoring the original configuration	p. 20

EU DECLARATION OF CONFORMITY

CHERUBINI S.p.A. declares that the product is in conformity with the relevant Union harmonisation legislation:

Directive 2014/35/EU

Directive 2014/30/EU

Directive 2011/65/EU

The full text of the EU declaration of conformity is available upon request at the following website: www.cherubini.it.

ELECTRICAL CONNECTIONS

- To prevent any danger or malfunction, the size of electrical control components connected to the motor must be compatible with the electrical features of the motor.
- Means for disconnection must be incorporated in the fixed wiring in accordance with the national installation standards.
- The selectors inverting the direction of rotation of the motor must be provided with mechanical interlocking.
- Invert the brown and the black conductor to change the direction of rotation.
- **NEVER** connect two or more selectors to the same motor.
- For outdoor use, provide the appliance with a supply cord with designation H05RN-F containing at least 2% of carbon.
- Cable length between motor and control-switch maximal 50 m.
In case of cable length more than 50 m an interface-relay have to be used.

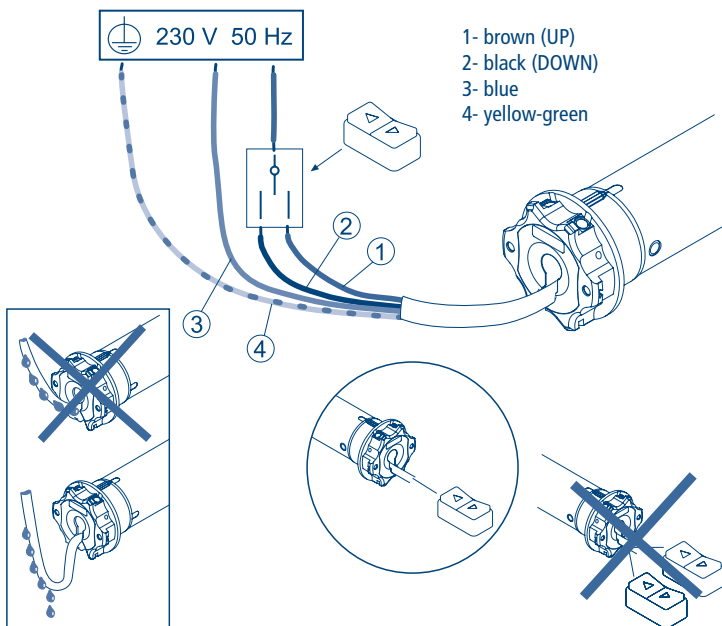

HOW TO PREPARE THE MOTOR

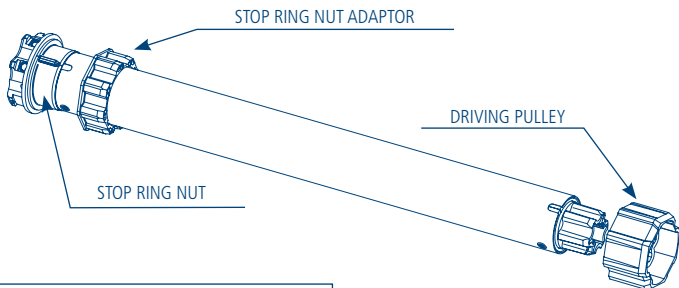

ENGLISH

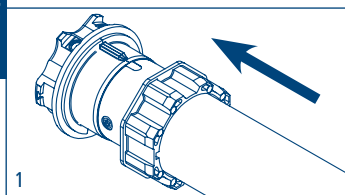

1. Insert the adaptor in the stop ring nut mating the groove with the reference notch and push till they touch.

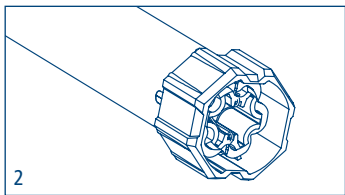

2. Fix the driving pulley on the motor pin until the stop pin clicks.

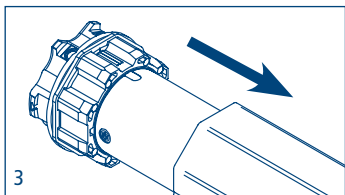

3. Insert the motor fully in the rolling tube.

NB: If you use tubes with a round form, the driving pulley must be fixed to the tube, and the installation is to be paid by the person who installs the system. For other tube sections the fitting is optional, but strongly recommended.

KEY TO SYMBOLS

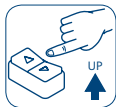

Press the
UP-button



Press the
DOWN-button

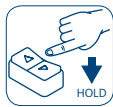

Press and hold
down the button

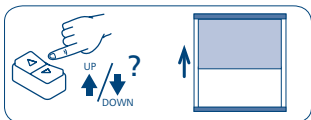

Press the up or down button to raise
the awning

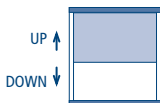

Motor
rotation to
confirm

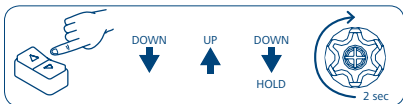

Press the buttons as indicated in rapid sequence and hold the button
down at the step marked by "HOLD", to check the motor confirmation
movement.

COMAND SEQUENCES EXAMPLE

Most of the command sequences have three or six distinct steps.

The buttons should be pressed quickly (<0.5 sec) as indicated in the sequence.

The time interval between each step should not be more than 1 second, otherwise the
command sequence will be cancelled.

To receive confirmation that the sequence has been accepted by the motor, the button
must be held down at the final step marked by HOLD.

Command sequence example in 3 steps:



Attention! If the sequence requires a repetition of the same commands
(Up+Up/Down+Down), an interposition of the Stop position could be necessary
depending on the type of switch in use.

LIMIT SWITCH SETTING

The motor can learn the limit switches only in manual mode.

As long as both of the limit switch positions have not been learned, the motor will move briefly, stop and then start back up again.

PROCEDURE FOR LIMIT SWITCH SETTING

Depending on your individual needs, it's possible to learn first either the upper or the lower limit switch.

EXAMPLE 1:

SETTING THE UPPER LIMIT SWITCH AS FIRST POSITION

If the awning is already completely closed up, it must be first opened out to about 20 cm, then proceed as follows.

Using the button switch, bring the awning up to the desired position (for cassette-awnings, hold the button pressed until the motor stops automatically on the closing position).

To set the upper limit switch position perform the indicated sequence of commands (UP-UP-UP) with the button to be linked to the ascent.

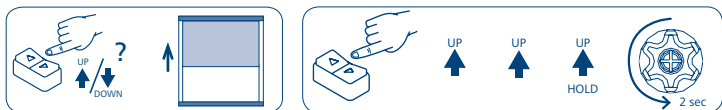

Using the button to be linked to descent bring the awning down to the desired position. To set the lower limit switch position perform the indicated sequence of commands (DOWN-DOWN-DOWN).

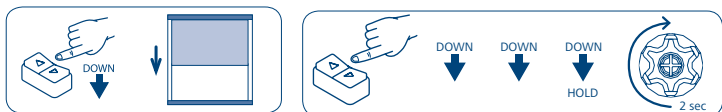

EXAMPLE 2:

SETTING THE LOWER LIMIT SWITCH AS FIRST POSITION

If the awning is already completely lowered, it must be first raised about 20 cm, then proceed as follows.

Using the button switch, bring the awning down to the desired position.

To set the lower limit switch position perform the indicated sequence of commands (DOWN-DOWN-DOWN) with the button to be linked to descent.

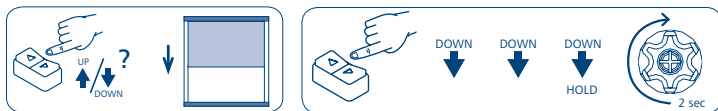

Using the button to be linked to ascent bring the awning up to the desired position (for cassette-awnings, hold the button pressed until the motor stops automatically on the closing position).

To set the upper limit switch position perform the indicated sequence of commands (UP-UP-UP).

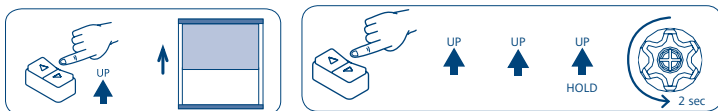

CHANGING LIMIT SWITCHES

The following command sequences may be performed only after the limit switches have been set and only when the motor is in one of the two limit switch positions.

DELETING OF SINGLE LIMIT SWITCH POSITIONS

Deleting of the UPPER limit switch.

Take the awning to the upper limit switch and perform the sequence:

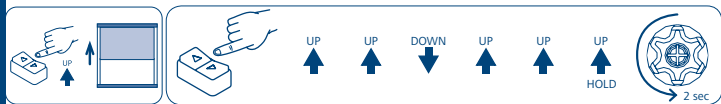

Deleting of the LOWER limit switch.

Take the awning to the lower limit switch and perform the sequence:

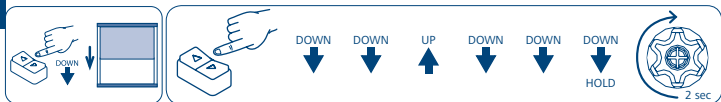

DELETING OF ALL LIMIT SWITCH POSITIONS

From the UPPER position

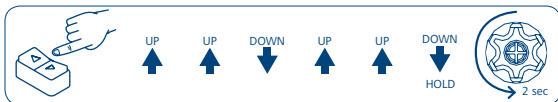

From the LOWER position

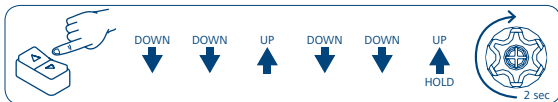

Deleting of one or both limit switches is indicated by the motor pausing briefly before moving again until both limit switch positions have been memorised again.

PLEASE NOTE: When the limit switches are deleted, the super-sensitivity settings are also deleted.

ACTIVATION AND ADJUSTMENT OF THE SUPER-SENSITIVITY

The super-sensitivity feature for obstacles when descending may be enabled on three levels only after both limit switches have been set.

From the UPPER position

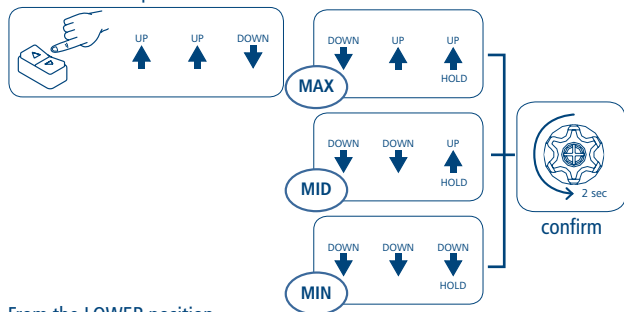

From the LOWER position

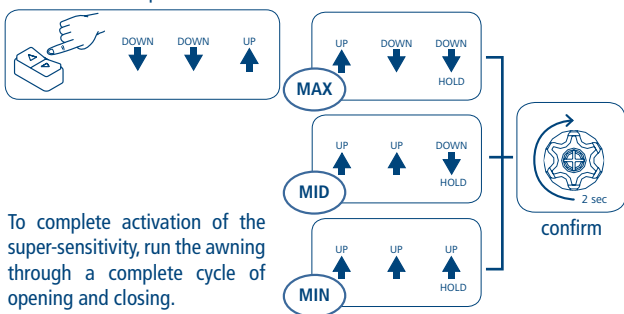

To complete activation of the super-sensitivity, run the awning through a complete cycle of opening and closing.

DEACTIVATION SUPER-SENSITIVITY FUNCTION

From the UPPER position

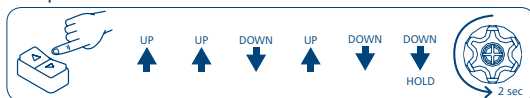

From the LOWER position

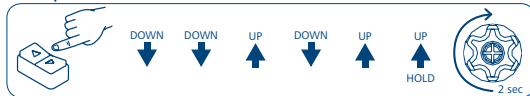

LIMIT SWITCHES AND OBSTACLE DETECTION

Obstacle detection in ASCENT

Obstacle detection in ascent is enabled only after both the limit switches have been set. In the event of obstacle detection in ascent, the motor will stop without making any movements backwards.

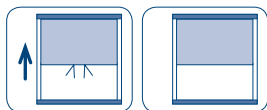

Obstacle detection in DESCENT

In the event of obstacle detection in descent, with the super-sensitivity feature on, the motor stops and makes a backwards safety movement.

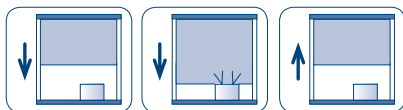

RESTORING THE ORIGINAL CONFIGURATION

PLEASE NOTE: recovery of the default configuration will delete the limit switches and disabling the super-sensitivity.

To restore the original motor configuration perform the procedure as described below:

- Connect both the brown and black motor wires under the same switch, e.g. UP.

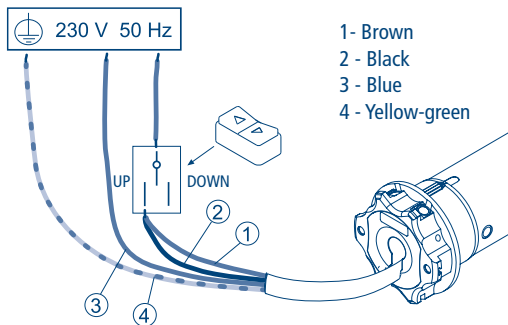

- Press the UP button for at least 2 seconds.
- Disconnect and then restore the original control switch electrical connections (see page 13).

CHERUBINI S.p.A.

Via Adige 55
25081 Bedizzole (BS) - Italy
Tel. +39 030 6872.039 | Fax +39 030 6872.040
info@cherubini.it | www.cherubini.it

CHERUBINI Iberia S.L.

Avda. Unión Europea 11-H
Apdo. 283 - P. I. El Castillo
03630 Sax Alicante - Spain
Tel. +34 (0) 966 967 504 | Fax +34 (0) 966 967 505
info@cherubini.es | www.cherubini.es

CHERUBINI France S.a.r.l.

ZI Du Mas Barbet
165 Impasse Ampère
30600 Vauvert - France
Tél. +33 (0) 466 77 88 58 | Fax +33 (0) 466 77 92 32
info@cherubini.fr | www.cherubini.fr

CHERUBINI Deutschland GmbH

Siemensstrasse, 40 - 53121 Bonn - Deutschland
Tel. +49 (0) 228 962 976 34 / 35 | Fax +49 (0) 228 962 976 36
info@cherubini-group.de | www.cherubini-group.de

