

CHERUBINI

tocco italiano dal 1947

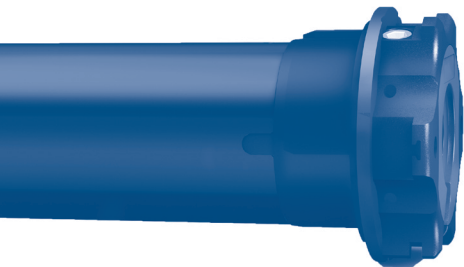

ROLL RX



MOTORE TUBOLARE RADIO CON
REGOLAZIONE MANUALE DEL FINECORSO

IT

RADIO TUBULAR MOTOR WITH
MECHANICAL LIMIT SWITCH ADJUSTMENT

EN

MOTOR MIT INTEGRIERTEM FUNKEMPFÄNGER
UND MECHANISCHER ENDABSCHALTUNG

DE

MOTEUR TUBULAIRE RADIO AVEC
RÉGLAGE MÉCANIQUE DU FIN DE COURSE

FR

MOTOR RADIO CON REGULACIÓN MECÁNICA
DE LOS FINES DE CARRERA

ES



ISTRUZIONI - INSTRUCTIONS - EINSTELLANLEITUNGEN
INSTRUCTIONS - INSTRUCCIONES

Table of contents:

How to prepare the motor	p. 22
Electrical connections	p. 23
Compatible remote controls	p. 24
Key to symbols	p. 24-25
Command sequences example	p. 25
Function open/close programming remote control	p. 26-27
Setting the first remote control	p. 28
Automatic disabling of the first remote control setting function	p. 28
Adjustement of the limit switches	p. 28
Setting the rotation direction of the motor	p. 29
Setting of additional remote controls	p. 30
Remote control memory clearing	p. 30
Restore the factory mode	p. 30
Full memory clearing	p. 31
Closing force adjustment	p. 32
Maximum closing force adjustment (100%)	p. 32
Compatible devices	
Mistral sensor	p. 33
Rugiada (TX rain-sensor)	p. 34
Anemometers	p. 34
Special functions	
Short-term setting of a remote control	p. 36
Setting the A530058 pocket remote control	p. 36
Electric wiring to motor command for UP-DOWN mode (2 independent UP-DOWN buttons)	p. 37
Command management from white wire	p. 38
EU Declaration of conformity	p. 93

HOW TO PREPARE THE MOTOR

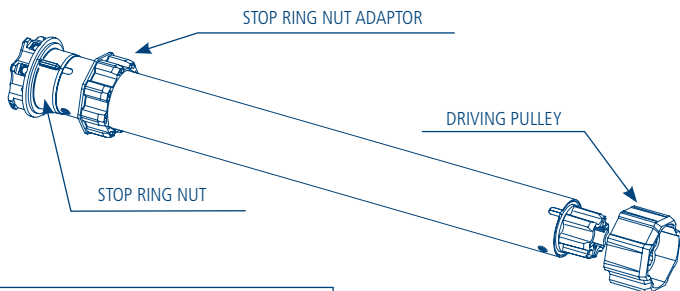

ENGLISH

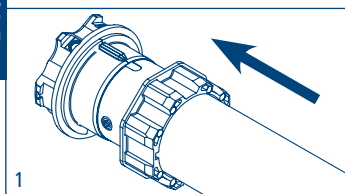

1. Insert the adaptor in the nut mating the groove with the reference notch and push till they touch.

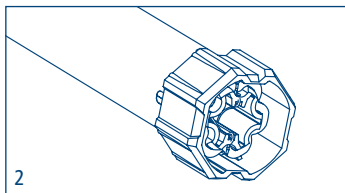

2. Fix the driving pulley on the motor pin until the stop pin clicks.

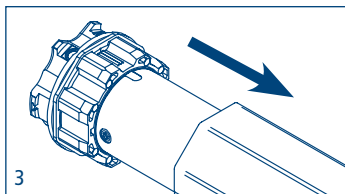

3. Insert the motor fully in the rolling tube.

NB: If you use tubes with a round form, the driving pulley must be fixed to the tube, and the installation is to be paid by the person who installs the system. For other tube sections the fitting is optional, but strongly recommended.

ELECTRICAL CONNECTIONS

- In order to prevent dangerous situations or malfunctioning, the electrical command elements wired to the motor must be sized according to the motor's electrical features.
- Means for disconnection must be incorporated in the fixed wiring in accordance with the national installation standards.
- For outdoor use, provide the appliance with a supply cable with designation H05RN-F containing at least 2% of carbon.
- If not used, the white wire must be insulated. It is dangerous to touch the white wire when the motor is powered.

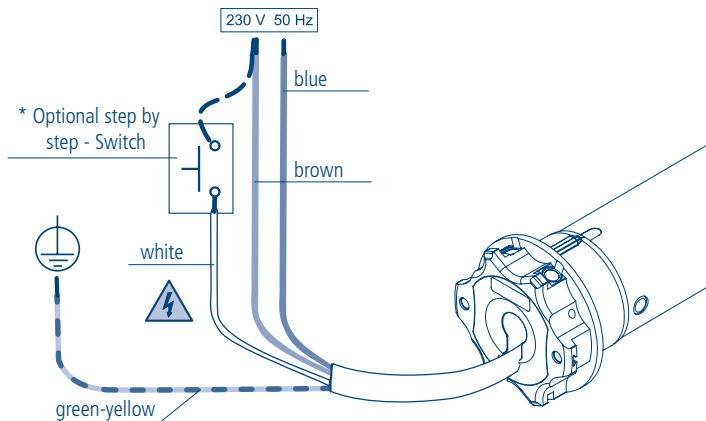

- * Installing this button is optional. The connection can be done differently using the brown wire or the blue wire. The button affords the possibility to command the motor in stepping mode (up, stop, down, stop, up, stop, down, stop..)

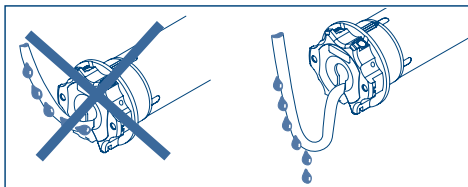

COMPATIBLE REMOTE CONTROLS

GIRO

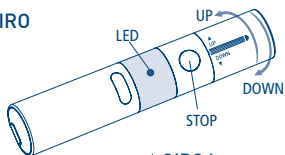

GIRO Wall

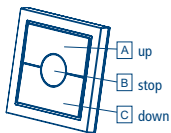

GIRO Plus

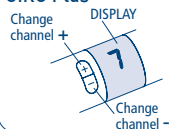

GIRO Lux

Activating the Sun sensor



Deactivating the Sun sensor

GIRO P-Lux

Change channel



Activating/ Deactivating the Sun sensor

POP

POP Lux

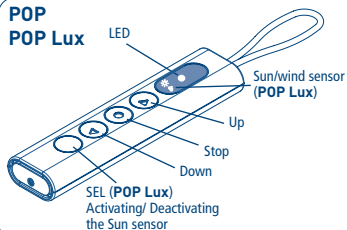

POP Plus

POP P-Lux

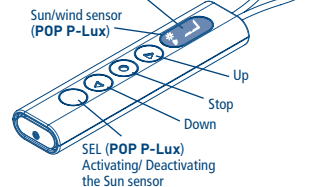

SKIPPER
SKIPPER Lux
SKIPPER Plus
SKIPPER P-Lux

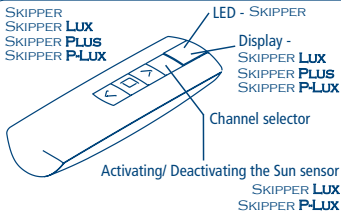

SKIPPER LCD
SKIPPER SENSO

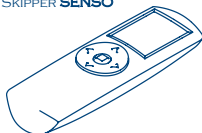

Check the specific instruction book

A530058 Remote Control with 4 independent channels

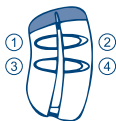

KEY TO SYMBOLS

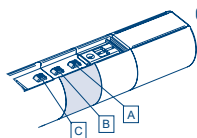

GIRO

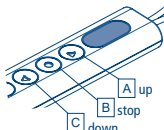

POP

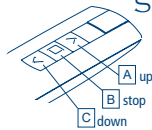

SKIPPER



crc
Create Remote Controls

KEY TO SYMBOLS

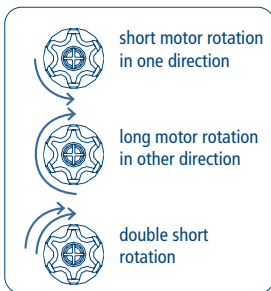
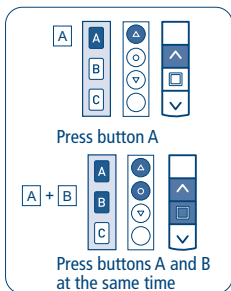
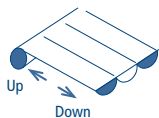
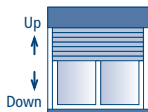

COMMAND SEQUENCES EXAMPLE

Most of the command sequences have three distinct steps, at the end of which the motor indicates if the step has been concluded positively or not, by turning in different ways. This section is provided to demonstrate the motor indications. The buttons must be pressed as shown in the sequence, without taking more than 4 seconds between one step and the next. If more than 4 seconds are taken, the command is not accepted and the sequence must be repeated. Command sequence example:

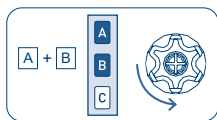

Step 1

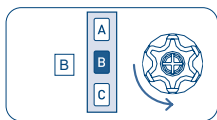

Step 2

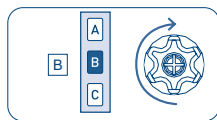

Step 3

As we can see from the example, when the sequence ends positively, the motor returns to its starting position in one long rotation. In fact, two short rotations in the same direction correspond to one long rotation in the opposite direction. The motor returns to the starting position even when the sequence is not completed; in this case by performing one or two short rotations. Example of a wrong sequence:

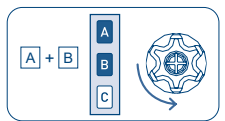

Step 1

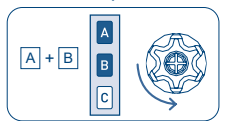

Step 1

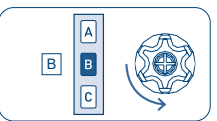

Step 2



FUNCTION OPEN/CLOSE PROGRAMMING

REMOTE CONTROL SKIPPER PLUS - SKIPPER LUX - SKIPPER P-LUX REMOTE CONTROL POP PLUS - POP LUX - POP P-LUX

To prevent accidental changes to the programming of the motor during the daily use of the remote control, the possibility of programming is disabled automatically 8 hours after sending the last sequence (A+B or B+C).

CHECKING THE STATUS OF THE FUNCTION

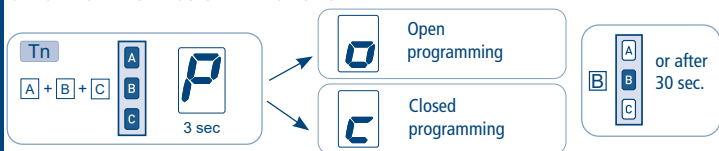

To change the status of the function, see the sequences "ENABLE/DISABLE PROGRAMMING".

ENABLE PROGRAMMING

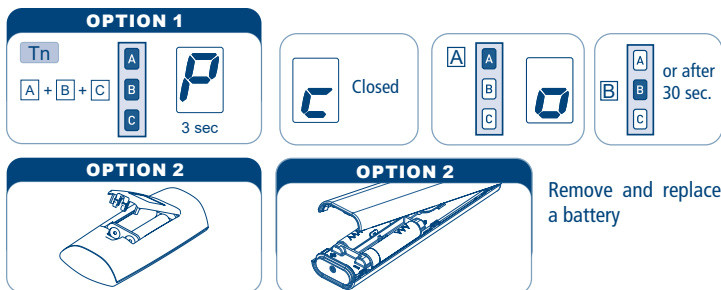

Remove and replace a battery

Proceed with programming as the instructions booklet.

DISABLE PROGRAMMING



FUNCTION OPEN/CLOSE PROGRAMMING REMOTE CONTROL SKIPPER - SKIPPER WALL - SERIES GIRO

To prevent accidental changes to the programming of the motor during the daily use of the remote control, the possibility of programming is disabled automatically 8 hours after sending the last sequence (A+B or B+C).

CHECKING THE STATUS OF THE FUNCTION

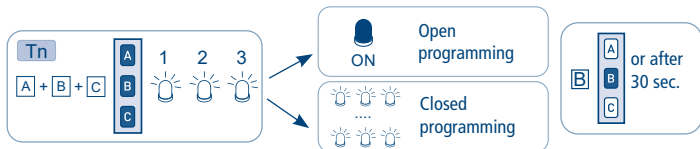

To change the status of the function, see the sequences "ENABLE/DISABLE PROGRAMMING".

ENABLE PROGRAMMING

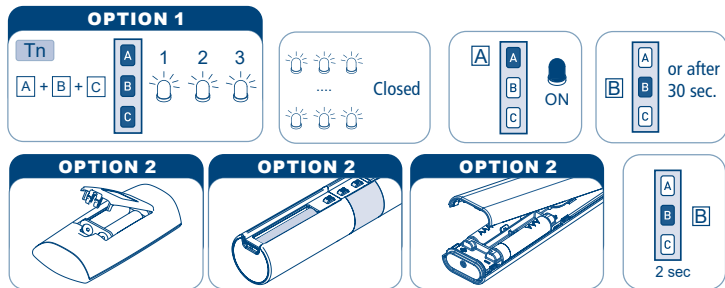

Remove one battery and wait minimum 5 seconds or press any button.

Proceed with programming as the instructions booklet.

DISABLE PROGRAMMING



SETTING THE FIRST REMOTE CONTROL

This operation can only be performed when the motor is new, or after a total delete of the memory.

During this step, power up only one motor at time!

T1: First remote control to be set

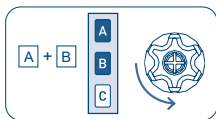

T1

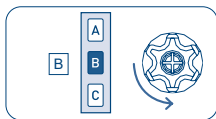

T1

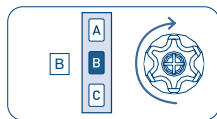

T1 (2 sec)

AUTOMATIC DISABLING OF THE FIRST REMOTE CONTROL SETTING FUNCTION

Every time you connect the power supply to the motor, you have 3 hours to store the first remote control. After this time, the ability to store the remote control is disabled. To reset the timer of the function you have to disconnect and reconnect the power supply to the motor.

NB: Until the remote control has been memorised, the wired control of the motor will operate in "dead-man" mode.

ADJUSTEMENT OF THE LIMIT SWITCHES

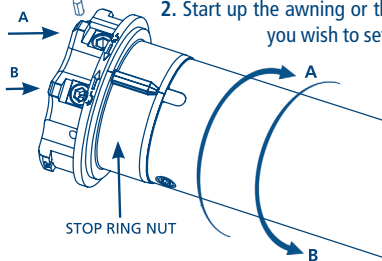
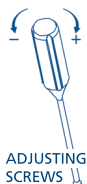

1. To decide which adjusting screw to fix, simply watch the direction of rotation of the stop ring nut: if the stop ring nut pulled by the roller goes in direction A, use the adjusting screw A to set the limit switch in that direction. If it goes to the opposite direction (B), use the adjusting screw B.
2. Start up the awning or the rolling shutter in the direction in which you wish to set the first limit switch. After a few turns the motor will stop on the preset stop.
3. Screw the adjusting screw suited to the direction (see point 1.) in direction "+" till it gets to the chosen position.
4. Invert the engine sense of direction and set the second limit switch.

SETTING THE ROTATION DIRECTION OF THE MOTOR

The operation can be performed via remote control or using the white wire. Every time you perform one of the two sequences below you reverse the output direction of the motor.

From the remote control:

Tn: Already programmed remote control

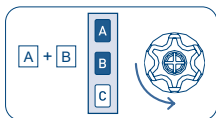

Tn

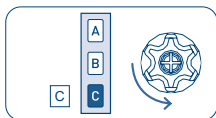

Tn

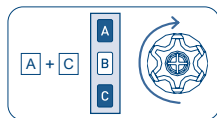

Tn (4 sec)

From the wired control:

The sequence of this operation is the following:

- 1) Disconnect the power supply from the motor, via the main switch for example.
- 2) Connect the white motor wire to the brown wire (phase) or to the blue wire (neutral).
- 3) Connect the power supply to the motor, which rotates briefly in one direction.
- 4) Disconnect the power supply from the motor for at least 4 seconds.
- 5) Connect the motor to the power supply, after about 2 seconds the motor performs a short rotation up or down. Within 3 seconds disconnect the power supply, for example using the main switch.
- 6) Disconnect the white wire from the motor.

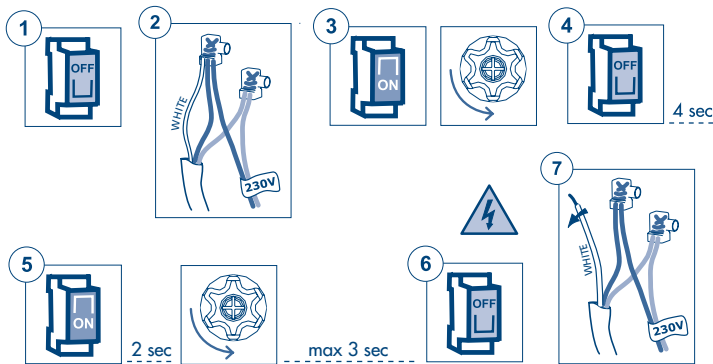

SETTING OF ADDITIONAL REMOTE CONTROLS

Up to 15 remote controls can be set.

Tn: Already programmed remote control

Tx: Additional remote control

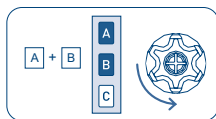

Tn

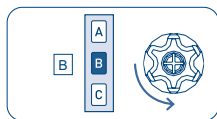

Tn

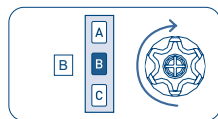

Tx (2 sec)

REMOTE CONTROL MEMORY CLEARING

It is possible to delete singly all the memorized remote controls. When the last one is deleted the motor initial condition is restored. The same applies to the single channels of a multichannel remote control: just select the channel to cancel.

Tn: Remote control to be cleared

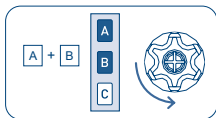

Tn

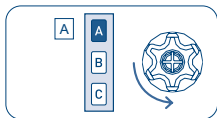

Tn

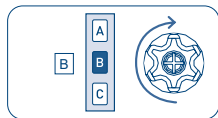

Tn (2 sec)

RESTORE THE FACTORY MODE

Tn: Already programmed remote control

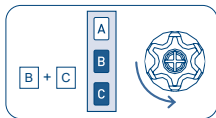

Tn

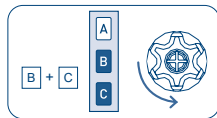

Tn

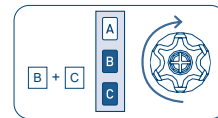

Tn (4 sec)

The following settings are now in factory mode: direction of rotation, timeout and white wire control mode.

FULL MEMORY CLEARING

The full memory clearing can be performed in two ways:

1) WITH THE REMOTE CONTROL

Tn: Already programmed remote control

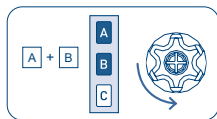

Tn

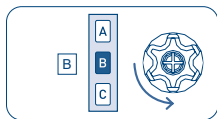

Tn

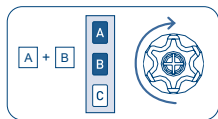

Tn (4 sec)

2) WITH THE WHITE WIRE

Do this operation only in case of emergency, if all remote controls are no longer operating. To delete the memory we have to access the white wire of the motor.

The sequence of this operation is the following:

- 1) Disconnect the power supply from the motor, via the main switch for example.
- 2) Connect the white motor wire to the brown wire (phase) or to the blue wire (neutral).
- 3) Connect the power supply to the motor, which rotates briefly in one direction.
- 4) Disconnect the power supply from the motor for at least 4 seconds.
- 5) Connect the motor to the power supply, after about 2 seconds the motor performs a short rotation up or down. After about 6 seconds the motor performs a long rotation in the opposite direction.
- 6) Disconnect the power supply from the motor.
- 7) Separate the white wire from the brow/blue wire. Insulate the white wire, in an appropriate way, before reconnecting the power supply.

At this point it is possible to proceed with the setting of the first remote control.

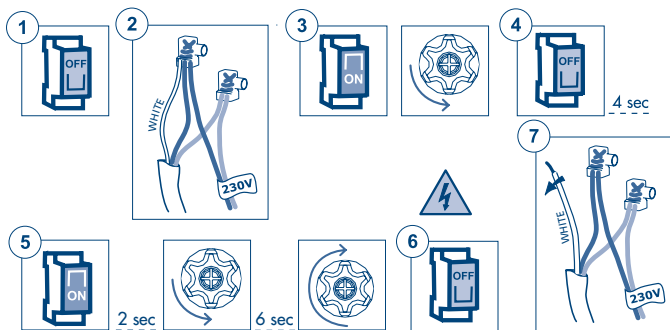

CLOSING FORCE ADJUSTMENT

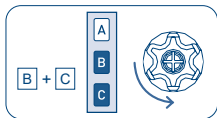

Tn

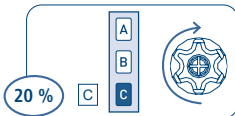
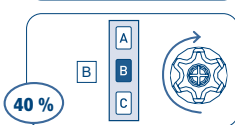
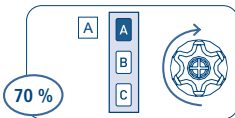
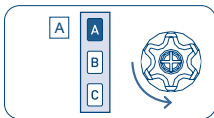

2 sec

This system, the only one of its kind, guarantees that cassette-awnings remain perfectly closed, without any danger of the canvas suffering excessive traction. The system works in all kinds of applications, thanks to the possibility of manually adjusting the closing force. The motor is factory set to a closing force of 40% of the nominal torque (e.g.: 40% of 50 Nm = 20 Nm). This force can be changed very easily by the remote control. It can be reduced by 20% or increased up to 70%, depending on the desired result.

MAXIMUM CLOSING FORCE ADJUSTMENT (100%)

A close attention on activating this function is recommended, excessive closing force may damage the awning.

By activating this function the motor will apply its maximum nominal torque, (e.g. 100% of 50 Nm = 50 Nm).

Tn: Already programmed remote control

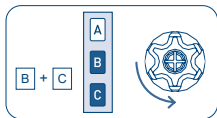

Tn

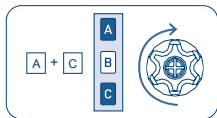
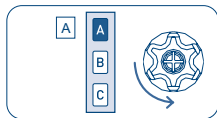

2 sec

COMPATIBLE DEVICES

MISTRAL SENSOR

It detects movements caused by the wind on the awning arms.

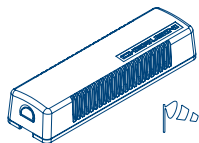

MISTRAL - Ref. A520012

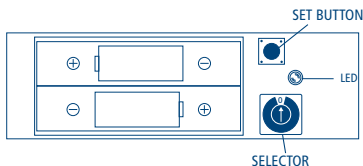

SETTING THE SENSOR

To associate the sensor to the control unit, a remote control must be already memorized. Set the selector to the 0 position and then perform this sequence:

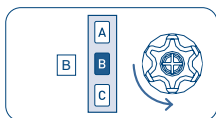
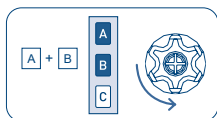

2 sec

DELETING THE SENSOR

To delete the sensor from the control unit, an already programmed remote control must be used. Set the selector to the 0 position; if active wait for the sensor to go off and then perform this sequence:

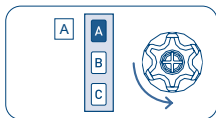
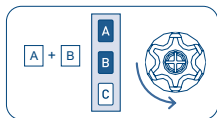

2 sec

For the complete description of the functions of this device see the instruction booklet that came in the box.

RUGIADA (TX RAIN-SENSOR)

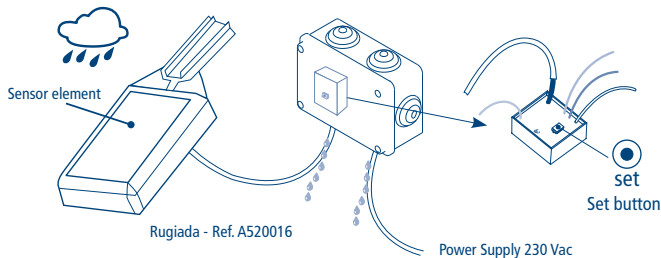

ANEMOMETERS



SETTING

To associate the sensor to the control unit, a remote control must be already memorised. The setting sequence is the following:

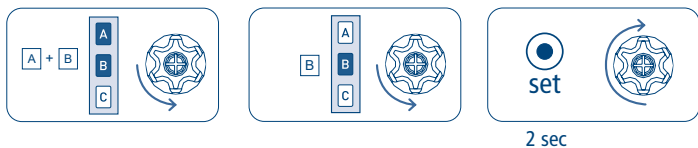

DELETING

To delete the sensor from the control unit, an already programmed remote control must be used. The deleting sequence is the following:

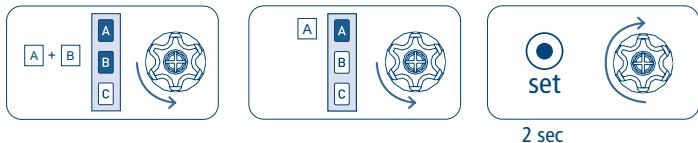

For the complete description of the functions of these devices see the instruction booklet that came in the box.

ENABLE / DISABLE THE SUN SENSOR

(WindTec Lux)

To enable (automatically) or disable (manually) the sun sensor refer to the instruction manual provided with the sensor or the remote control you want to use.

TEST MODE (WINDTEC/WINDTEC LUX)

This function is useful to check proper radio communications and to perform the wind and sun function test.

To activate the TEST function, hold the SET button down for around 2 seconds, until the awning opens for 10 seconds and closes briefly to confirm that the test has been activated. The Test function lasts for 3 minutes, during which the wind and sunlight threshold settings can be checked, without waiting for activation times. After 3 minutes, the WindTec sensor returns to normal operational mode. During the wind-alarm the red led inside the control unit is on.

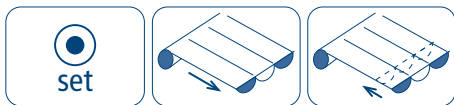

2 sec

WIND FUNCTION TEST (WINDTEC, WINDTEC LUX)

To avoid errors during the wind function test, it is suggested that the sunlight function be deactivated. By spinning the anemometer fins, when the speed detected by the sensor exceeds the threshold set, the motor commands the closing of the awnings.

SUN FUNCTION TEST (WINDTEC LUX)

Make sure that the sunlight function is on. When the sensor detects a change in the sunlight intensity, it opens the awning if the sunlight intensity goes above the threshold set, or it closes the awning if the light intensity goes below the threshold set. It is possible to repeat this test several times, so as to find the desired adjustment levels precisely.

SPECIAL FUNCTIONS

SHORT-TERM SETTING OF A REMOTE CONTROL

This function makes it possible to store a remote control temporarily, for example, with the purpose of setting the limit switches during assembly in the factory. A later final saving of the remote control will be possible using the appropriate command sequence (see: "SETTING THE FIRST REMOTE CONTROL"). The operations described below can be carried out only when the motor has just come out of the factory or after a full memory clearing (see: "FULL MEMORY CLEARING"). The motor makes the following operations possible only within the time limits described in order to make sure that the short-term setting is used only in the installation or factory setting phase and not during daily use. Power up the motor, make sure that no other motors having an empty memory are powered up in the same operating range.

Within 30 seconds after start, press the B and C buttons simultaneously until the motor gives a confirmation signal.

The remote control will remain stored for 5 minutes, while the motor is powered up. After 5 minutes or when the motor has its power cut off, the remote control will be cancelled.

T1: First remote control to be set

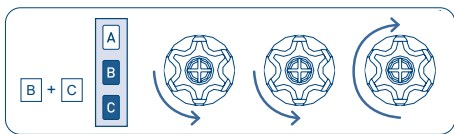

T1

SETTING THE A530058 POCKET REMOTE CONTROL

NB: The new pocket remote control can be set only after programming of a previous remote control as the traditional Cherubini remote controls (Skipper, Giro or POP - 3 buttons Up-Down-Stop remote control).

HOW TO PROCEED TO SET THE BUTTON ON THE POCKET REMOTE CONTROL

Tn: Already programmed remote control

Tx: Pocket remote control to be set

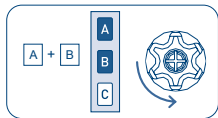

Tn

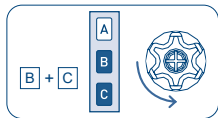

Tn

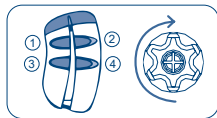

Tx (2 sec)

After to have pressed for minimal 2 seconds one of the 4 buttons on the pocket remote control, this one will be memorized on the step-by-step mode (UP-STOP-DOWN-STOP). The following buttons will be not memorized and have to be done with previous described sequence, and could be used to move additional motors.

DELETING ONE BUTTON ON THE POCKET REMOTE CONTROL

The buttons saved may be deleted individually according to the following sequence:

Tn: Already programmed remote control

Tx: Pocket remote control with button to be deleted

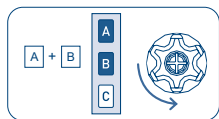

Tn

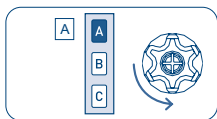

Tn

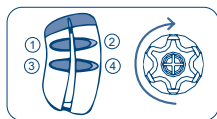

Tx (2 sec)

To confirm the operation the motor will do a short shunt and the button, which has to be pressed for minimal 2 second, will be deleted.

ELECTRIC WIRING TO MOTOR COMMAND FOR UP-DOWN MODE (2 independent UP-DOWN buttons)

To connect the switch, use only kind of switches with mechanical or electrical interlock, to prevent to press both buttons at same time.

The motor automatically recognizes the switch-type (with 1 or 2 buttons) and sets the proper operational mode.

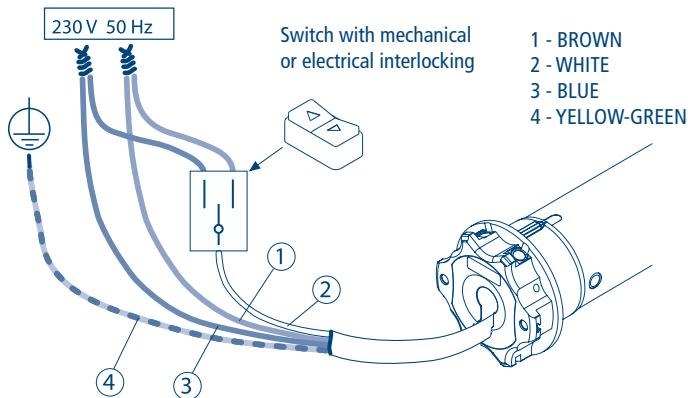

COMMAND MANAGEMENT FROM WHITE WIRE

UP-STOP-DOWN-STOP / UP-DOWN / UP-DOWN "DEAD MAN"

NB: The default function provided in the motors leaving the factory is UP-STOP-DOWN-STOP for singular UP/DOWN button switch. (Not for the switch with two independent UP-DOWN buttons!)

PROCEDURE TO CHANGE THE CONTROL MODE:

Tn: Already programmed remote control

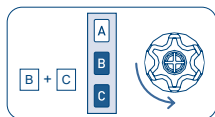

Tn

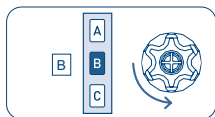

Tn

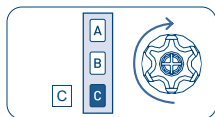

Tn (2 sec)

The possible settings are 3 and are available in the following order:

- UP-STOP-DOWN-STOP (factory setting)
- UP-DOWN (for 2 independent buttons)
- UP-DOWN "DEAD MAN" (for 2 independent buttons)

To switch from one setting to the following, perform the sequence as many times as necessary to reach the desired setting.

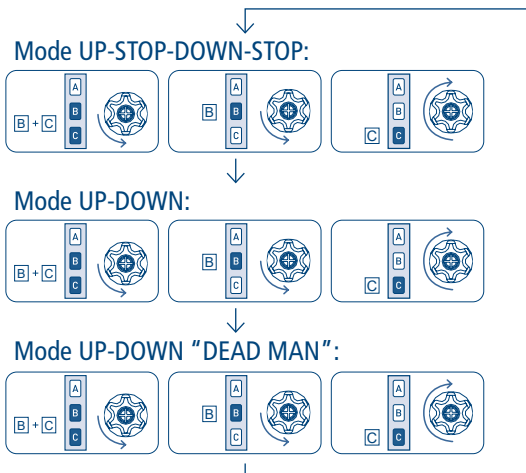

IT DICHIARAZIONE DI CONFORMITÀ UE

CE CHERUBINI S.p.A. dichiara che il prodotto è conforme alle pertinenti normative di armonizzazione dell'Unione:

Direttiva 2014/53/UE, Direttiva 2011/65/UE.

Il testo completo della dichiarazione di conformità UE è disponibile facendone richiesta sul sito: www.cherubini.it.

EN EU DECLARATION OF CONFORMITY

CE CHERUBINI S.p.A. declares that the product is in conformity with the relevant Union harmonisation legislation:

Directive 2014/53/EU, Directive 2011/65/EU.

The full text of the EU declaration of conformity is available upon request at the following website: www.cherubini.it.

DE EU-KONFORMITÄTSERKLÄRUNG

CE CHERUBINI S.p.A. erklärt der produkt erfüllt die einschlägigen Harmonisierungsrichtsvorschriften der Union:

Richtlinie 2014/53/EU, Richtlinie 2011/65/EU.

Der vollständige Text der EU-Konformitätserklärung kann unter unserer Web-Seite www.cherubini.it, gefragt werden.

FR DÉCLARATION UE DE CONFORMITÉ

CE CHERUBINI S.p.A. déclare que le produit est conforme à la législation d'harmonisation de l'Union applicable:

Directive 2014/53/UE, Directive 2011/65/UE.

Le texte complet de la déclaration UE de conformité est disponible en faisant requête sur le site internet: www.cherubini.it.

ES DECLARACIÓN UE DE CONFORMIDAD

CE CHERUBINI S.p.A. declara que el producto es conforme con la legislación de armonización pertinente de la Unión:

Directiva 2014/53/UE, Directiva 2011/65/UE.

El texto completo de la declaración UE de conformidad puede ser solicitado en: www.cherubini.it.

CHERUBINI S.p.A.

Via Adige 55
25081 Bedizzole (BS) - Italy
Tel. +39 030 6872.039 | Fax +39 030 6872.040
info@cherubini.it | www.cherubini.it

CHERUBINI Iberia S.L.

Avda. Unión Europea 11-H
Apdo. 283 - P. I. El Castillo
03630 Sax Alicante - Spain
Tel. +34 (0) 966 967 504 | Fax +34 (0) 966 967 505
info@cherubini.es | www.cherubini.es

CHERUBINI France S.a.r.l.

ZI Du Mas Barbet
165 Impasse Ampère
30600 Vauvert - France
Tél. +33 (0) 466 77 88 58 | Fax +33 (0) 466 77 92 32
info@cherubini.fr | www.cherubini.fr

CHERUBINI Deutschland GmbH

Siemensstrasse, 40 - 53121 Bonn - Deutschland
Tel. +49 (0) 228 962 976 34 / 35 | Fax +49 (0) 228 962 976 36
info@cherubini-group.de | www.cherubini-group.de

