

CHERUBINI

tocco italiano dal 1947

PLUG&PLAY SHORT PLUG&PLAY PLUS WAVE WIRE

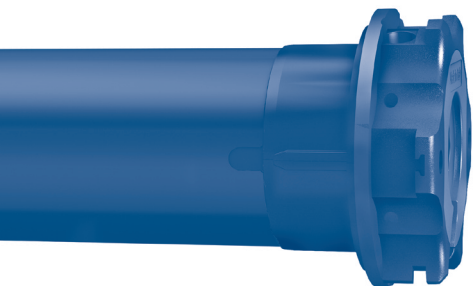

MOTORE TUBOLARE CON REGOLAZIONE AUTOMATICA
O MANUALE DEL FINECORSO ELETTRONICO

I

TUBULAR MOTOR WITH AUTOMATIC OR MANUAL
ADJUSTMENT OF THE ELECTRONIC LIMIT SWITCH

GB

ROHRMOTOR MIT AUTOMATISCHER ODER MANUELLER
EINSTELLUNG DER ELEKTRONISCHEN ENDLAGEN

D

MOTEUR TUBULAIRE AVEC RÉGLAGE AUTOMATIQUE OU
MANUEL DES FINS DE COURSE ÉLECTRONIQUES

F

MOTOR TUBULAR CON REGULACIÓN AUTOMÁTICA O
MANUAL DEL FIN DE CARRERA ELECTRONICO

E



ISTRUZIONI - INSTRUCTIONS - EINSTELLANLEITUNGEN
INSTRUCTIONS - INSTRUCCIONES

Table of contents:

Electrical connections	p. 13
Electrical connections Plug & Play Plus - Wave Wire	p. 14
Electrical connections Plug & Play Short	p. 14
How to prepare the motor	p. 15
Restoring the original configuration	p. 16
Plug & Play Short - Plug & Play Plus	
Instruction for use in automatic mode	p. 16
Plug & Play Plus - Wave Wire	
Instruction for use in manual mode	p. 17
Instruction for use in mixed mode.....	p. 17
Key to symbols	p. 17
Command sequences example	p. 17
Adjustment of the limit switches with Plug & Play Plus	p. 18
Adjustment of the limit switches with Wave Wire	p. 18
Deletion of individual limit switch positions	p. 19
Deleting the opening and closing limit switch	p. 19
Motor actions at limit switch stops and obstacles	p. 20
EU declaration of conformity	p. 20

ELECTRICAL CONNECTIONS

- To prevent any danger or malfunction, the size of electrical control components connected to the motor must be compatible with the electrical features of the motor.
- Means for disconnection must be incorporated in the fixed wiring in accordance with the national installation standards.
- The selectors inverting the direction of rotation of the motor must be provided with mechanical interlocking.
- Invert the brown and the black conductor to change the direction of rotation.
- **NEVER** connect two or more selectors to the same motor.
- For outdoor use, provide the appliance with a supply cord with designation H05RN-F containing at least 2% of carbon.
- Cable length between motor and control-switch maximal 50 m.
In case of cable length more than 50 m an interface-relay have to be used.

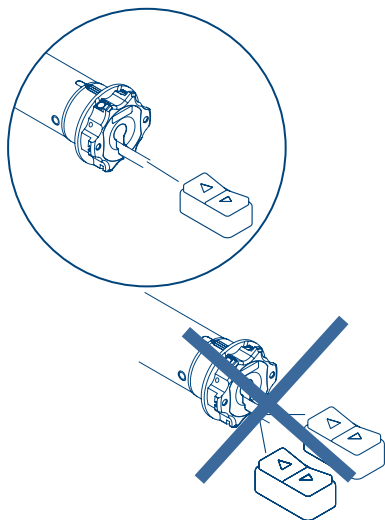
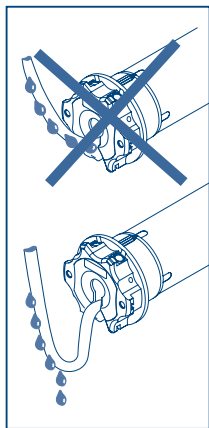

ELECTRICAL CONNECTIONS PLUG & PLAY PLUS - WAVE WIRE

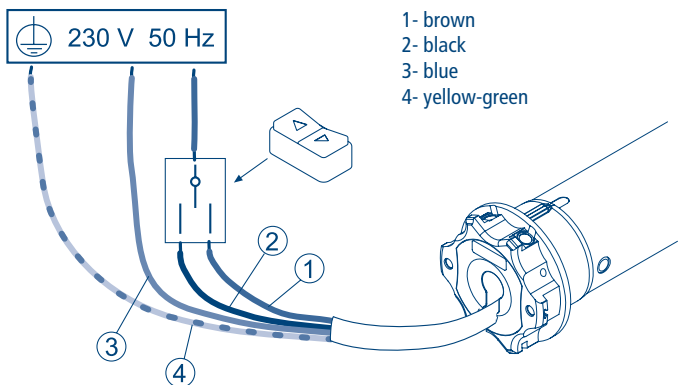

ELECTRICAL CONNECTIONS PLUG & PLAY SHORT

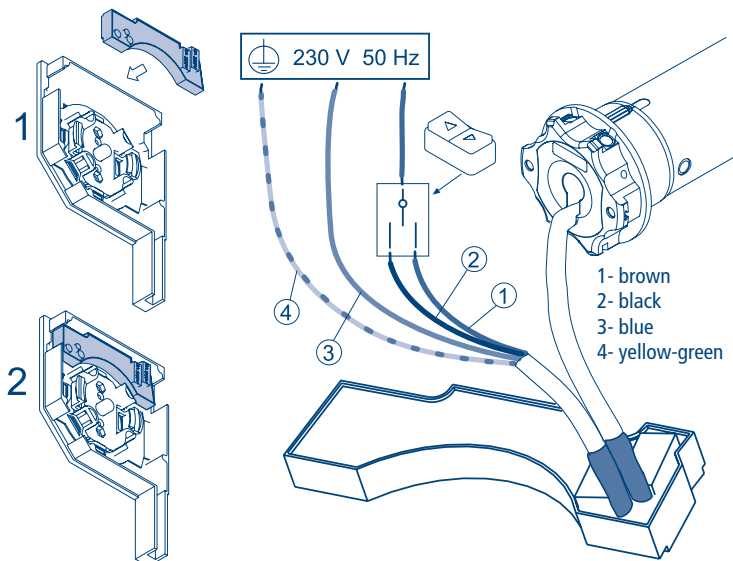

HOW TO PREPARE THE MOTOR

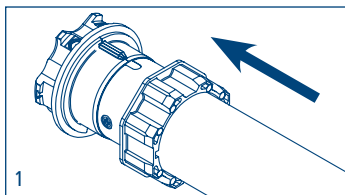
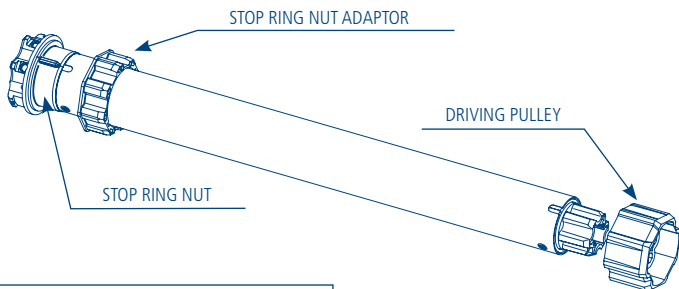

1. Insert the adaptor in the stop ring nut mating the groove with the reference notch and push till they touch.

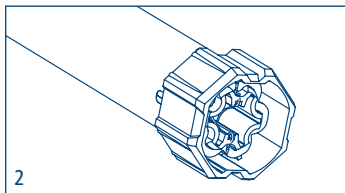

2. Fix the driving pulley on the motor pin until the stop pin clicks.

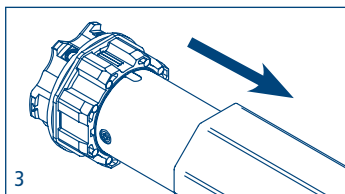

3. Insert the motor fully in the rolling tube.

NB: If you use tubes with a round form, the driving pulley must be fixed to the tube, and the installation is to be paid by the person who installs the system. For other tube sections the fitting is optional, but strongly recommended.

RESTORING THE ORIGINAL CONFIGURATION

To restore the original motor configuration perform the procedure as described below:

- Connect both the brown and black motor wires under the same switch, e.g. UP.
- Press the UP button for at least 2 seconds.
- Disconnect and then restore the original control switch electrical connections (see page 14).

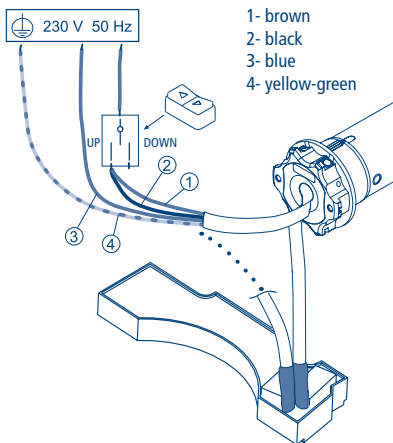

PLUG & PLAY SHORT - PLUG & PLAY PLUS

INSTRUCTION FOR USE IN AUTOMATIC MODE

The tubular motor is very simple to be used and installed, it does not need any regulation as it automatically detects the position of limit switch.

The rolling shutter must be equipped with:

- a) security locks or stiff fixing springs,
- b) fixed or removable stoppers for end slats.

It is very important to check the sturdiness of the rolling shutter.

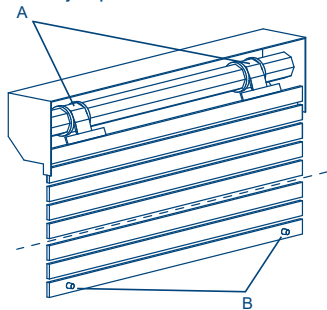

PLEASE NOTE: Until both limit switch positions have been memorized:

- **Plug & Play Plus** at start up the motor makes an initial brief movement with a 0.5 second delay and then it moves with a 0.5 second delay.

PLUG & PLAY PLUS - WAVE WIRE

INSTRUCTION FOR USE IN MANUAL MODE

PLUG & PLAY PLUS	WAVE WIRE
In this mode the following devices are optional: a) security locks or stiff fixing springs, b) fixed or removable stoppers for end slats.	The motor Wave Wire is specific for use with cassette awning: the upper limit switch (closing position) can be set automatically. For other types of awnings it's possible to set both limit switches manually.

INSTRUCTION FOR USE IN MIXED MODE

It is always possible to memorize limit switches of the rolling shutter/awning in mixed mode, for example:

- Opening limit switch: automatic with mechanical blocks.
- Closing limit switch: manual with sequence on the button panel.

KEY TO SYMBOLS

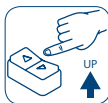

Press the
UP-button



Press the
DOWN-button

UP ↑
DOWN ↓

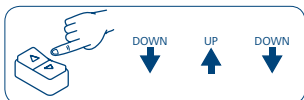
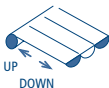

Press the buttons quickly according to the sequence indicated.

PLEASE NOTE: Until both limit switch positions have been memorized:

- **Plug & Play Plus** at start up the motor makes an initial brief movement with a 0.5 second delay and then it moves with a 0.5 second delay.
- **Wave Wire** at start up the motor moves with a 0.5 second delay.

COMAND SEQUENCES EXAMPLE

Most of the command sequences have three or six distinct steps.

The buttons must be pressed for less than 0.5 seconds as shown in the sequence, without taking more than 1 second between one step and the next. If more than 1 second is taken, the command is not accepted and the sequence must be repeated.

Command sequence example:

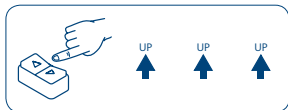

Attention! If the sequence requires a repetition of the same commands (Up+Up/ Down+Down), an interposition of the Stop position could be necessary depending on the type of switch in use.

PLUG & PLAY PLUS - WAVE WIRE

ADJUSTMENT OF THE LIMIT SWITCHES WITH PLUG & PLAY PLUS

SETTING THE UPPER LIMIT SWITCH POSITION

If the rolling shutter is completely open, you have firstly to drive it down by around 20 cm.

Bring the rolling shutter to the opening position using the UP button. Follow the command sequence given in order to save the opening position (UP-UP-UP).

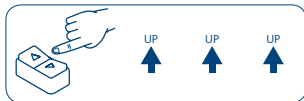
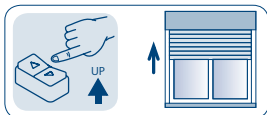

SETTING THE LOWER LIMIT SWITCH POSITION

Bring the rolling shutter to the closing position using the DOWN button. Follow the command sequence given in order to save the closing position (DOWN-DOWN-DOWN).

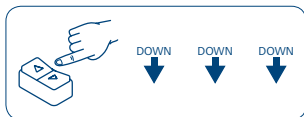
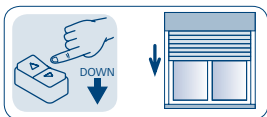

ADJUSTMENT OF THE LIMIT SWITCHES WITH WAVE WIRE

SETTING THE UPPER LIMIT SWITCH POSITION

If the awning is completely closed, you have firstly to drive it down by around 20 cm.

Bring the awning to the closing position using the UP button. Follow the command sequence given in order to save the closing position (UP-UP-UP).

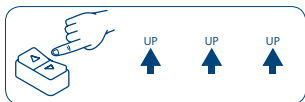
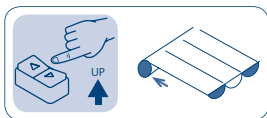

SETTING THE LOWER LIMIT SWITCH POSITION

Bring the awning to the opening position using the DOWN button. Follow the command sequence given in order to save the opening position (DOWN-DOWN-DOWN).

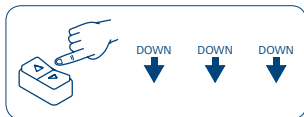
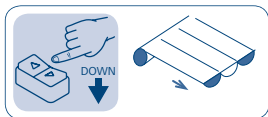

DELETION OF INDIVIDUAL LIMIT SWITCH POSITIONS

Deletion of the UPPER limit switch

Bring the rolling shutter/awning to the upper limit switch and proceed as follows:

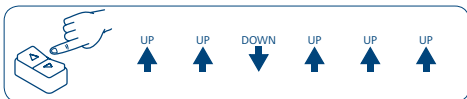

Deletion of the LOWER limit switch

Bring the rolling shutter/awning to the lower limit switch and proceed as follows:

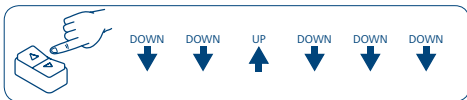

DELETING THE OPENING AND CLOSING LIMIT SWITCH

Deletion of the limit switches from the UPPER limit switch position

Bring the rolling shutter/awning to the upper limit switch and proceed as follows:

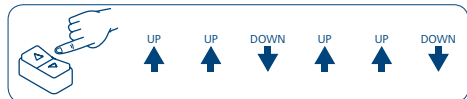

Deletion of the limit switches from the LOWER limit switch position

Bring the rolling shutter/awning to the lower limit switch and proceed as follows:

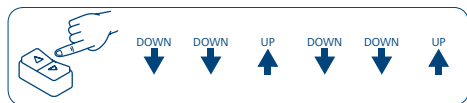

After deletion of one or both limit switches the motor has a 0.5 seconds run delay until both limit switch positions have been memorised again either in automatic or manual mode.

MOTOR ACTIONS AT LIMIT SWITCH STOPS AND OBSTACLES

ENGLISH

	LIMIT SWITCH STOPS (blinds with stoppers and/or stiff fixing springs, or cassette awnings).	OBSTACLE DETECTION WHEN ASCENDING AND DESCENDING (only when descending for blinds with stiff fixing springs).
P&P Plus Ø 35 P&P Plus Ø 35 V43	It always goes to the stop and reverses direction to release tension.	P&P Plus Ø 35 it stops and reverses direction for 1/3 of the travel. P&P Plus Ø 35 V43 it stops and does not reverse direction.
Wave Wire P&P Short (Until 12/2017)	It always goes to the stop and DOES NOT reverse direction to release tension.	It stops and does not reverse direction.
P&P Short (Starting from 01/2018)	It always goes to the stop and reverses direction to release tension.	It stops and reverses direction to release tension.

After the limit switches have been set, the motors act differently when they reach the mechanical stop or if there is an obstacle.

EU DECLARATION OF CONFORMITY



CHERUBINI S.p.A. declares that the product is in conformity with the relevant Union harmonisation legislation:

Directive 2014/35/EU

Directive 2014/30/EU

Directive 2011/65/EU

The full text of the EU declaration of conformity is available upon request at the following website: www.cherubini.it.

CHERUBINI S.p.A.

Via Adige 55
25081 Bedizzole (BS) - Italy
Tel. +39 030 6872.039 | Fax +39 030 6872.040
info@cherubini.it | www.cherubini.it

CHERUBINI Iberia S.L.

Avda. Unión Europea 11-H
Apdo. 283 - P. I. El Castillo
03630 Sax Alicante - Spain
Tel. +34 (0) 966 967 504 | Fax +34 (0) 966 967 505
info@cherubini.es | www.cherubini.es

CHERUBINI France S.a.r.l.

ZI Du Mas Barbet
165 Impasse Ampère
30600 Vauvert - France
Tél. +33 (0) 466 77 88 58 | Fax +33 (0) 466 77 92 32
info@cherubini.fr | www.cherubini.fr

CHERUBINI Deutschland GmbH

Siemensstrasse, 40 - 53121 Bonn - Deutschland
Tel. +49 (0) 228 962 976 34 / 35 | Fax +49 (0) 228 962 976 36
info@cherubini-group.de | www.cherubini-group.de

