

CLIMA PLUS RX CLIMA RX

CLIMA PLUS RX: tapparelle con meccanismo di basculamento
con/senza aggancio o apertura delle lame

I

CLIMA RX: tapparelle con meccanismo di basculamento
senza aggancio o apertura delle lame

CLIMA PLUS RX: rolling shutters with tilting mechanism
with/without coupling system or opening of the slats

GB

CLIMA RX: rolling shutters with tilting mechanism
without coupling system or opening of the slats

CLIMA PLUS RX: Rollladen mit Kippmechanismus
mit/ohne Einhaken oder Lamellenöffnung

D

CLIMA RX: Rollladen mit Kippmechanismus
ohne Einhaken oder Lamellenöffnung

CLIMA PLUS RX: volet avec mécanisme de basculement
avec/sans crochet d'attache ou d'ouverture des lames

F

CLIMA RX: volet avec mécanisme de basculement
sans crochet d'attache ou d'ouverture des lames

CLIMA PLUS RX: persianas con mecanismo de basculación
con/sin enganche o apertura de las lamas

E

CLIMA RX: persianas con mecanismo de basculación
sin enganche o apertura de las lamas



Table of contents

How to prepare the motor	p. 43
Electrical connections	p. 44
CHOICE OF THE PROGRAMMING MODES To be read before starting the programming!	p. 45
Motor programming from the remote control	p. 46
Compatible remote controls / Key to symbols	p. 46
Command sequences example	p. 47
Function open/close programming remote control	p. 48-49
Setting the first remote control	p. 50
Automatic disabling of the first remote control setting function	p. 50
Adjustment of the limit switches	p. 50
Setting in mode 1 (manual)	p. 50
Example 1: Setting first the opening position	p. 51
Example 2: Setting first the closing position	p. 52
Mode 2: limit switch setting (semi-automatic)	p. 53
Setting a middle position / Deleting the middle position	p. 54
Closing force adjustment	p. 55
Deleting the opening and closing limit switch	p. 55
Setting of additional remote controls / Remote control memory clearing	p. 56
Full memory clearing	p. 57
Special functions: Short-term setting of a remote control	p. 58
Slat tilting or slat opening mechanism setting / Operational notes.....	p. 58
SLAT TILTING MECHANISM SETTING (Remote control progr.).....	p. 59
Mode 1 - 2- 3 - 4 - 5	p. 59-63
Deleting the tilting functions / Slat tilting adjustment impulse	p. 64
Notes for the contemporaneous use of the middle position and the tilting / orientation functions	p. 65
Motor programming from the white wire	p. 66
Key to symbols / Command sequences example	p. 66
Motor programming from the white wire	p. 67
Adjustment of the limit switches	p. 67
Setting in mode 1 (manual)	p. 67
Example 1: Setting first the opening position	p. 68
Example 2: Setting first the closing position	p. 69
Mode 2: limit switch setting (semi-automatic)	p. 70
Setting/Deleting a middle position	p. 71
Closing force adjustment	p. 72
Deleting the opening and closing limit switch	p. 73
Special functions: Slat tilting or slat opening mechanism setting / Operational notes	p. 73
SLAT TILTING MECHANISM SETTING (Progr. from the white wire)	p. 74
Mode 1 - 2- 3 - 4 - 5	p. 74-78
Deleting the tilting functions.....	p. 79
Slat tilting adjustment impulse	p. 79
Command management from white wire UP-DOWN continuous movement/ UP-DOWN dead man .	p. 80
EU Declaration of conformity	p. 80

HOW TO PREPARE THE MOTOR

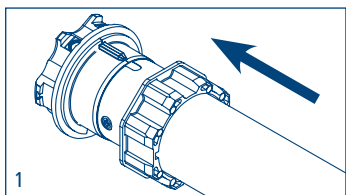
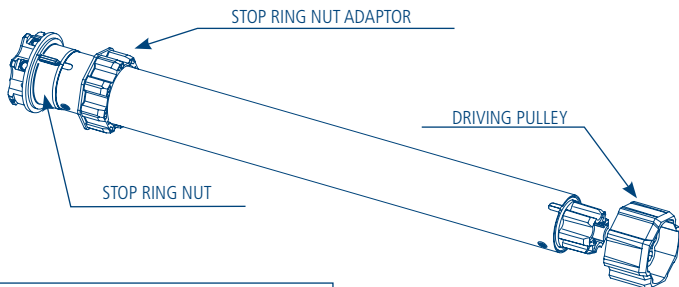

1. Insert the adaptor in the stop ring nut mating the groove with the reference notch and push till they touch.

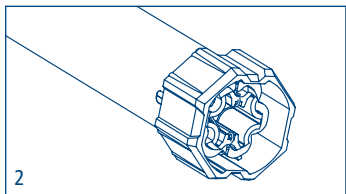

2. Fix the driving pulley on the motor pin until the stop pin clicks.

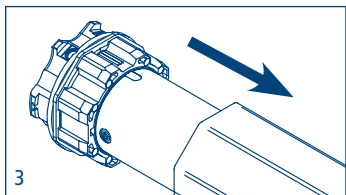

3. Insert the motor fully in the rolling tube.

NB: If you use tubes with a round form, the driving pulley must be fixed to the tube, and the installation is to be paid by the person who installs the system. For other tube sections the fitting is optional, but strongly recommended.

ELECTRICAL CONNECTIONS

- In order to prevent dangerous situations or malfunctioning, the electrical command elements wired to the motor must be sized according to the motor's electrical features.
- Means for disconnection must be incorporated in the fixed wiring in accordance with the national installation standards.
- For outdoor use, provide the appliance with a supply cable with designation H05RN-F containing at least 2% of carbon.
- If not used, the white wire must be insulated. It is dangerous to touch the white wire when the motor is powered.

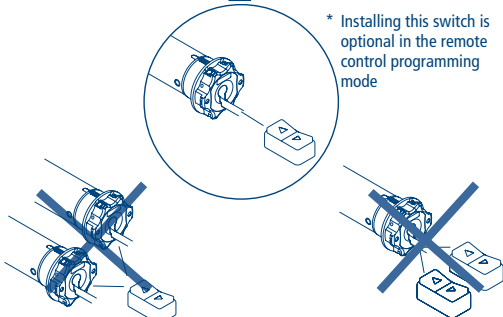
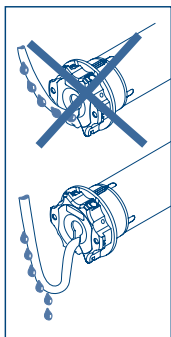
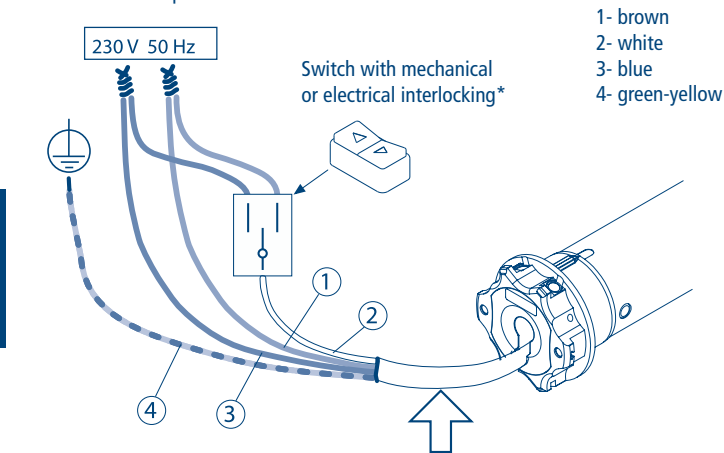

CHOICE OF THE PROGRAMMING MODES:

RADIO - WHITE WIRE - WHITE WIRE with the radio function active

The motor may be programmed using 3 modes:

- RADIO PROGRAMMING: Once the programming has been completed the motor enables use either by white-wire, by radio, or using both modes (radio/wire).
- WHITE WIRE PROGRAMMING:
 - After the adjustment of the limit switches using the white wire, programming remains active for 5 min. After 5 min have elapsed, the motor must be disconnected from its power supply and then reconnected in order to reprogram the system.
 - If the limit switches are set using the whitewire without programming a remote control, the radio function is automatically deactivated for programming and for later use. To reset the radio function, the activation sequence found on this page must be performed within 5 min from the adjustment of the limit switches (or after having disconnected and then reconnected the motor from its power supply).
 - Once the programming has been completed the motor enables only the use of the white wire, unless the radio function is reactivated.
- WHITE WIRE PROGRAMMING WITH RADIO FUNCTION ACTIVE: To be able to use both modes (radio and wire), a remote control must be programmed before the adjustment of the limit switches in the white wire mode. Once the programming has been completed the motor enables use either by white wire, by radio, or using both modes (radio/wire).

ACTIVATION/DEACTIVATION OF THE REMOTE CONTROL FUNCTION

To activate/deactivate the remote control function, follow the sequence shown below:

PLEASE NOTE: To deactivate the remote function it is first necessary to totally delete the remote controls from the memory of the motor (page 57).

Activation/deactivation from the OPENING position:

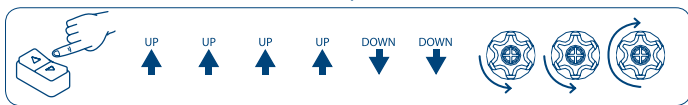

Activation/deactivation from the CLOSING position:

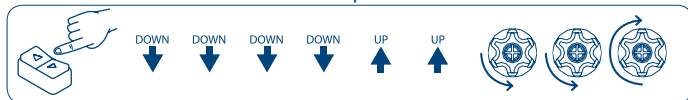

The confirmation movements indicate that the remote control function activation/deactivation procedure has been successfully carried out.

MOTOR PROGRAMMING

from the remote control

from the white wire

REMOTE CONTROL PROGR. p. 46-65

PROGR. FROM THE WHITE WIRE p. 66-80

MOTOR PROGRAMMING FROM THE REMOTE CONTROL COMPATIBLE REMOTE CONTROLS

REMOTE CONTROL PROGR.
ENGLISH

GIRO

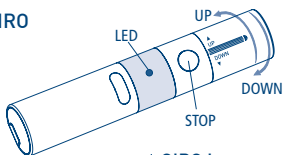

GIRO Wall

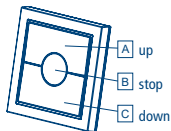

GIRO Plus

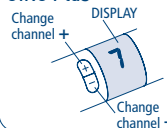

GIRO Lux

Activating the Sun sensor



GIRO P-Lux

Change channel

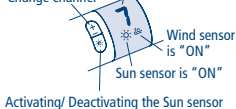

POP

POP Lux

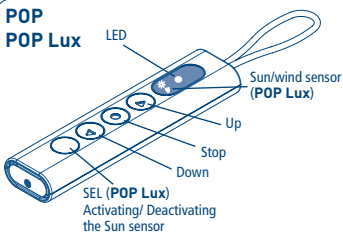

POP Plus

POP P-Lux

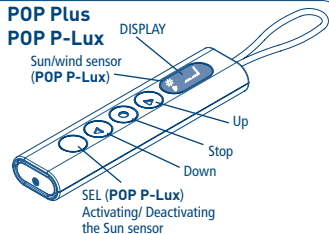

SKIPPER
SKIPPER Lux
SKIPPER Plus
SKIPPER P-Lux

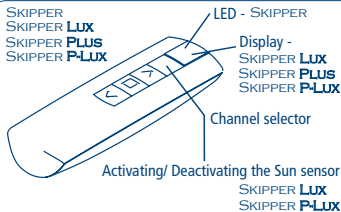

SKIPPER LCD
SKIPPER SENSO

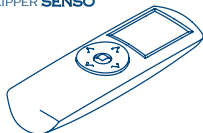

Check the specific instruction book

KEY TO SYMBOLS

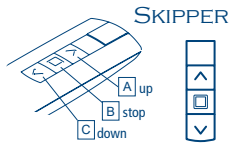
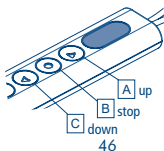
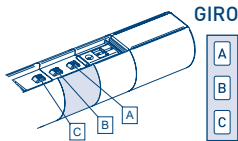

KEY TO SYMBOLS

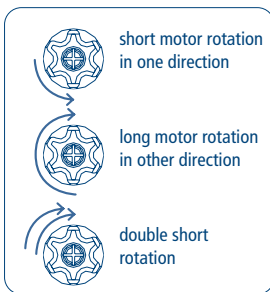
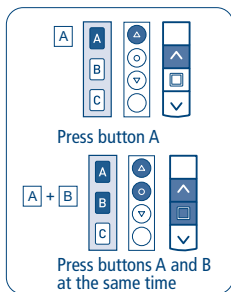
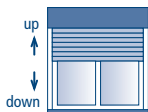

COMMAND SEQUENCES EXAMPLE

Most of the command sequences have three distinct steps, at the end of which the motor indicates if the step has been concluded positively or not, by turning in different ways. This section is provided to demonstrate the motor indications. The buttons must be pressed as shown in the sequence, without taking more than 4 seconds between one step and the next. If more than 4 seconds are taken, the command is not accepted and the sequence must be repeated. Command sequence example:

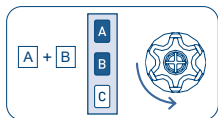

Step 1

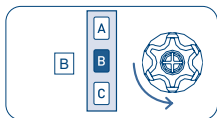

Step 2

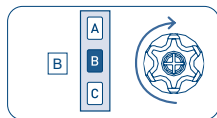

Step 3

As we can see from the example, when the sequence ends positively, the motor returns to its starting position in one long rotation. In fact, two short rotations in the same direction correspond to one long rotation in the opposite direction. The motor returns to the starting position even when the sequence is not completed; in this case by performing one or two short rotations. Example of a wrong sequence:

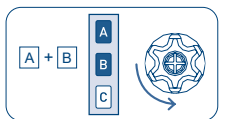

Step 1

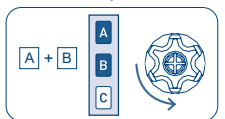

Step 1

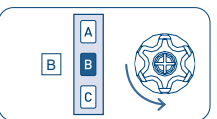

Step 2



FUNCTION OPEN/CLOSE PROGRAMMING

REMOTE CONTROL SKIPPER PLUS - SKIPPER LUX - SKIPPER P-LUX

REMOTE CONTROL POP PLUS - POP LUX - POP P-LUX

REMOTE CONTROL PROGR.

To prevent accidental changes to the programming of the motor during the daily use of the remote control, the possibility of programming is disabled automatically 8 hours after sending the last sequence (A+B or B+C).

CHECKING THE STATUS OF THE FUNCTION

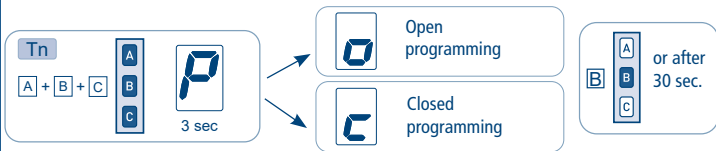

To change the status of the function, see the sequences "ENABLE/DISABLE PROGRAMMING".

ENGLISH

ENABLE PROGRAMMING

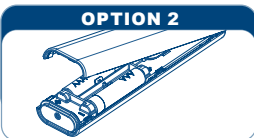
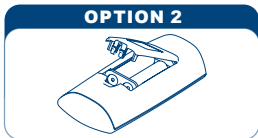
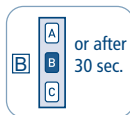
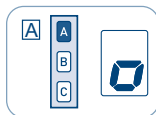
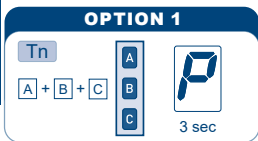

Remove and replace a battery

Proceed with programming as the instructions booklet.

DISABLE PROGRAMMING

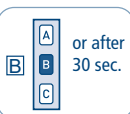
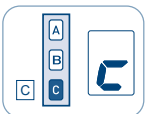
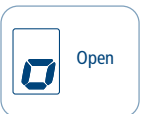
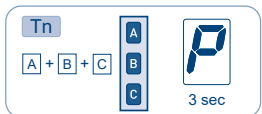

FUNCTION OPEN/CLOSE PROGRAMMING

REMOTE CONTROL SKIPPER - SERIES GIRO - REMOTE CONTROL POP

To prevent accidental changes to the programming of the motor during the daily use of the remote control, the possibility of programming is disabled automatically 8 hours after sending the last sequence (A+B or B+C).

CHECKING THE STATUS OF THE FUNCTION

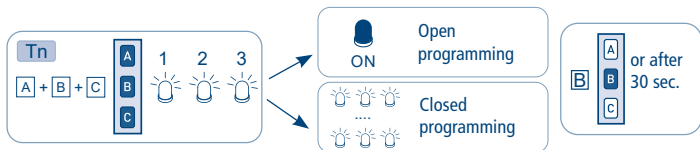

To change the status of the function, see the sequences "ENABLE/DISABLE PROGRAMMING".

ENABLE PROGRAMMING

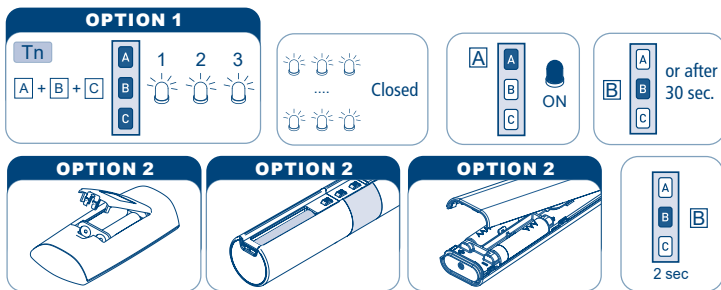

Remove one battery and wait minimum 5 seconds or press any button.

Proceed with programming as the instructions booklet.

DISABLE PROGRAMMING



SETTING THE FIRST REMOTE CONTROL

This operation can only be performed when the motor is new, or after a total delete of the memory.

During this step, power up only one motor at time!

T1: First remote control to be set

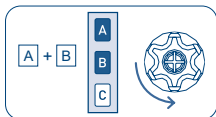

T1

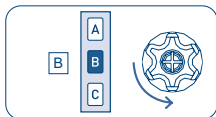

T1

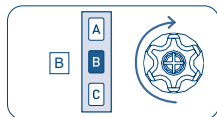

T1 (2 sec)

AUTOMATIC DISABLING OF THE FIRST REMOTE CONTROL SETTING FUNCTION

Every time you connect the power supply to the motor, you have 3 hours to store the first remote control. After this time, the ability to store the remote control is disabled. To reset the timer of the function you have to disconnect and reconnect the power supply to the motor.

ADJUSTMENT OF THE LIMIT SWITCHES

The motors have an electronic limit switch system with an encoder. This system ensures great reliability and precision in keeping the positions. Limit switch regulation is performed simply with the remote control. During setting, the motor moves only as long as the up or down button is pressed, stopping when the button is released. At the end of setting, press either the up or down button briefly to move the motor.

The adjustments of the limit switches can be done in different modes depending on whether the rolling shutter is equipped with lockdown hangers or physical stops.

SETTING IN MODE 1 (manual)

In this mode it doesn't matter whether or not the rolling shutter has got physical stops in the opening position and the lockdown hangers in the closing position. It is possible to choose whether to set the upper limit or the lower limit first. The correct rotation direction will only be identified after the first position is set so it is sometimes necessary to use the "up" or "down" button.

EXAMPLE 1: Setting first the opening position

SETTING THE OPENING POSITION

If the rolling shutter is completely open, you have first to drive it down by around 20 cm.

Hold the button A or C pressed and drive the rolling shutter to the opening position.

With physical stops: press button A or C until the motor stops automatically.

Without physical stops: use the button A or C to drive the rolling shutter to the necessary opening position.

To set the opening position, press buttons A (up) and B (stop) simultaneously for about 2 seconds, until the motor automatically performs a short "down" movement.

This move is the visual confirmation of the setting operation.

Tn: Already programmed remote control

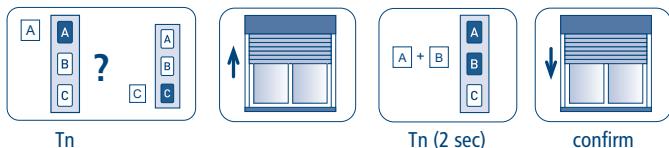

SETTING THE CLOSING POSITION

Pressing now the button C, drive completely down the rolling shutter to the closing position.

With lockdown hangers: press button C until the motor stops automatically.

Without lockdown hangers: use the button A or C to drive the rolling shutter to the necessary closing position.

To set the closing position, press buttons B (stop) and C (down) simultaneously for about 2 seconds, until the motor automatically performs a short "up" movement.

This move is the visual confirmation of the setting operation.

Tn: Already programmed remote control

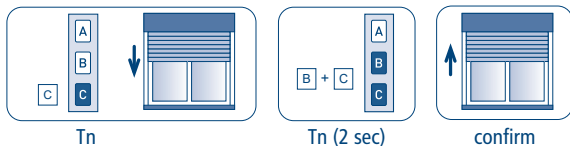

EXAMPLE 2:**Setting first the closing position****SETTING THE CLOSING POSITION**

If the rolling shutter is completely closed, you have first to drive it up by around 20 cm.

Hold the button A or C pressed and drive the rolling shutter to the closing position.

With lockdown hangers: press buttons A or C until the motor stops automatically.

Without lock down hangers: use the button A or C to drive the rolling shutter to the necessary closing position.

To set the closing position, press buttons B (stop) and C (down) simultaneously for about 2 seconds, until the motor performs automatically a short "up" movement.

This move is the visual confirmation of the setting operation.

Tn: Already programmed remote control

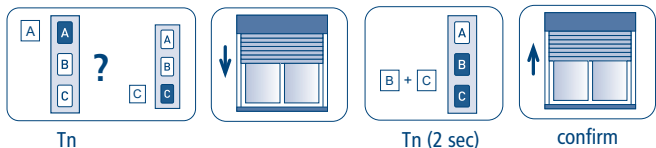
**SETTING THE OPENING POSITION**

Pressing now button A, drive completely up the rolling shutter to the opening position.

With physical stops: press button A until the motor stops automatically.

Without physical stops: use the button A or C to drive the rolling shutter to the necessary opening position.

To set the opening position, press buttons A (up) and B (stop) simultaneously for about 2 seconds, until the motor automatically performs a short "down" movement.

This move is the visual confirmation of the setting operation.

Tn: Already programmed remote control

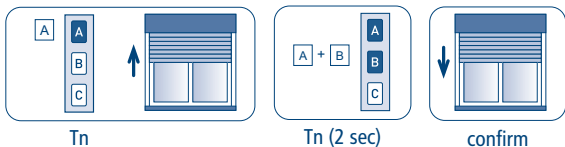

MODE 2: LIMIT SWITCH SETTING (semi-automatic)

To do the settings in this mode the rolling shutter has to be equipped with lockdown hangers in the closing position, but the rolling shutter does not need to have physical stops in the opening position. This mode of setting is helpful in cases where the factory will set the opening position and the closing position will be set automatically during the normal use.

In this mode, it's necessary to set first the opening position!! (Rolling shutter open!)

SETTING THE OPENING POSITION

If the shutter is already completely open, you have first to drive it down by about 20 cm.

Press button A or C and drive to the opening position.

With physical stops: press button A or C until the motor stops automatically.

Without physical stops: use buttons A and C to drive the rolling shutter to the necessary opening position.

To set the opening position, press button B (stop) for about 2 seconds, until the motor performs a short downwards movement. After this confirmation movement the motor brings back the rolling shutter to the opening position.

Tn: Already programmed remote control

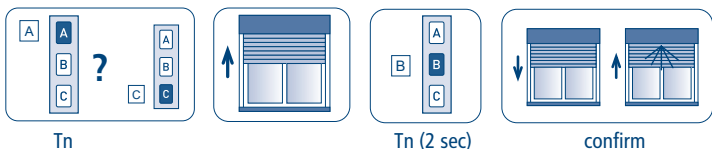

Now the drive direction is detected and the motor can be disconnected from the power. The closing position will be set automatically during the normal use. When the motor is powered up again, the remote control can be used normally. The lower limit switch position will be set automatically the first time the rolling shutter stops automatically in the closing position using the lockdown hangers. As the motor looks for a "mechanical" stop during each way down, if the Obstacle Recognition finds something is blocking the way (such as a protruding screw in the guide rails), it is necessary to raise the shutter again, remove the obstacle and to drive the motor back to the closing position to set the limit.

SETTING A MIDDLE POSITION

This function allows the rolling shutter to be set at a favourite middle position. When this middle position is memorised, you just press the STOP button for 2 seconds and automatically the motor will move the shutter to this position.

To memorise the middle position, move the rolling shutter to the desired position and then hold the STOP button down (for about 2 sec) until the motor gives confirmation.

Tn: Already programmed remote control



Tn (4 sec)

DELETING THE MIDDLE POSITION

If you want to delete the middle position, it can be done as described below.

To change this position, it's also necessary to delete first the memorised middle position. Before deleting it's necessary to drive the motor to the middle position (by pressing button B for 2 seconds), then press again button B (stop) for about 4 seconds until the motor confirms the operation by a longer movement.

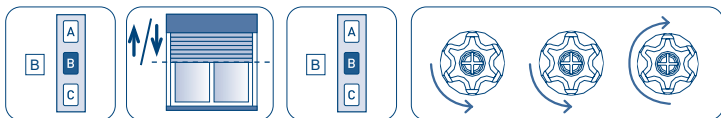

Tn (2 sec)

Tn (4 sec)

CLOSING FORCE ADJUSTMENT

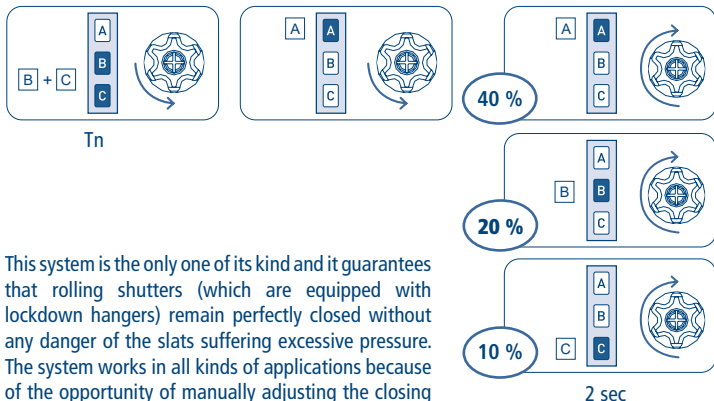

This system is the only one of its kind and it guarantees that rolling shutters (which are equipped with lockdown hangers) remain perfectly closed without any danger of the slats suffering excessive pressure. The system works in all kinds of applications because of the opportunity of manually adjusting the closing force.

The motor is factory set to a closing force of 20 % of the nominal torque. This force can be changed very easily by the remote control. It can be reduced by 10 % or increased up to 40 %, depending on the desired result.

DELETING THE OPENING AND CLOSING LIMIT SWITCH

Tn: Already programmed remote control

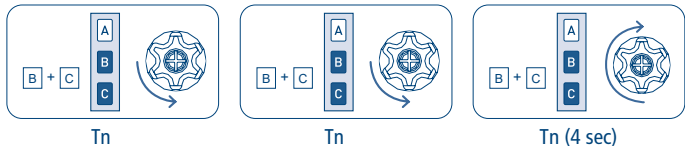

SETTING OF ADDITIONAL REMOTE CONTROLS

Up to 15 remote controls can be set.

Tn: Already programmed remote control

Tx: Additional remote control

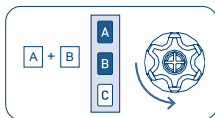

Tn

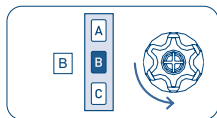

Tn

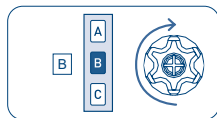

Tx (2 sec)

REMOTE CONTROL MEMORY CLEARING

It is possible to delete singly all the memorised remote controls. When the last one is deleted the motor initial condition is restored. The same applies to the single channels of a multichannel remote control: just select the channel to cancel before performing the sequence.

Tn: Remote control to be cleared

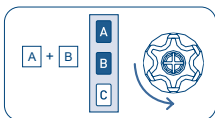

Tn

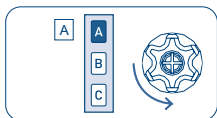

Tn

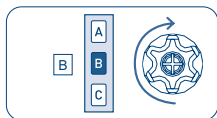

Tn (2 sec)

FULL MEMORY CLEARING

This full memory clearing does not delete the setting of the limit switch.

The full memory clearing can be performed in two ways:

1) WITH THE REMOTE CONTROL

Tn: Already programmed remote control

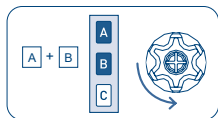

Tn

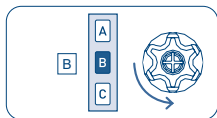

Tn

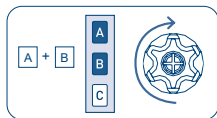

Tn (4 sec)

2) WITH THE WHITE WIRE

Do this operation only in case of emergency, if all remote controls are no longer operating. To delete the memory we have to access the white wire of the motor.

The sequence of this operation is the following:

- 1) Disconnect the power supply from the motor, via the main switch for example.
- 2) Connect the white motor wire to the brown wire (phase) or to the blue wire (neutral).
- 3) Connect the power supply to the motor, which rotates briefly in one direction.
- 4) Disconnect the power supply from the motor for at least 4 seconds.
- 5) Connect the power supply to the motor which performs one brief rotation in one direction after around 4 seconds and then a longer one in the opposite direction.
- 6) Disconnect the power supply from the motor.
- 7) Separate the white wire from the brow/blue wire. Insulate the white wire, in an appropriate way, before reconnecting the power supply.

At this point it is possible to proceed with the setting of the first remote control.

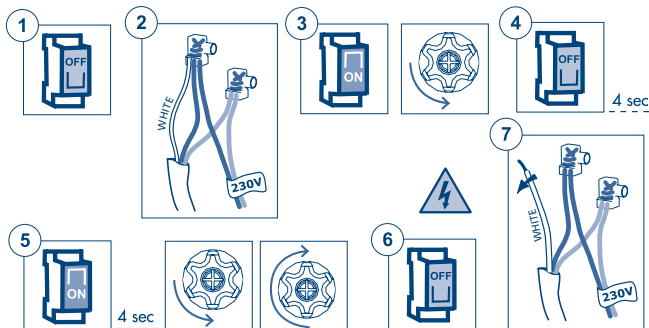

SPECIAL FUNCTIONS

SHORT-TERM SETTING OF A REMOTE CONTROL

This function makes it possible to store a remote control temporarily, for example, with the purpose of setting the limit switches during assembly in the factory. A later final saving of the remote control will be possible using the appropriate command sequence (see: "SETTING THE FIRST REMOTE CONTROL"). The operations described below can be carried out only when the motor has just come out of the factory or after a full memory clearing (see: "FULL MEMORY CLEARING"). The motor makes the following operations possible only within the time limits described in order to make sure that the short-term setting is used only in the installation or factory setting phase and not during daily use. Power up the motor, make sure that no other motors having an empty memory are powered up in the same operating range.

Within 30 seconds after start, press the B and C buttons simultaneously until the motor gives a confirmation signal.

The remote control will remain stored for 5 minutes, while the motor is powered up. After 5 minutes or when the motor has its power cut off, the remote control will be cancelled.

T1: First remote control to be stored

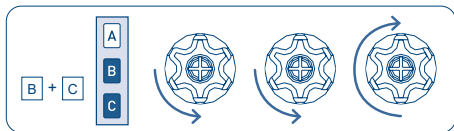

T1

SLAT TILTING OR SLAT OPENING MECHANISM SETTING

OPERATIONAL NOTES

- What is meant by "short command" on the remote control is to press and hold the button (A, B, C) for less than 2 sec. What is meant by "long command" on the remote control is press and hold the button (A, B, C) for more than 2 sec.
- During the slat tilting movement, the adjustment of the opening of the slats is limited to the minimum and the maximum of their opening.
- To enter into the slat tilting mode press the B button on the remote control with a long command (2 sec). To use the tilting / orientation function and the middle position function contemporaneously see the note on page 65.
- When one wishes to execute a long command, the motor also executes a short command.
- To stop the rolling shutter during movement, press the stop button on the remote control.

SLAT TILTING MECHANISM SETTING

(Not available on Clima RX)

MODE 1: Orientable roller shutter with coupling point for tilting function above the lower limit.

Only for roller shutter type Persyroll / Multiroll / Supergradhermetic / Supernova.
Not suitable for centralised control units. Not available on motors Ø 35.

After having memorised the limit switches, perform the following command sequence:

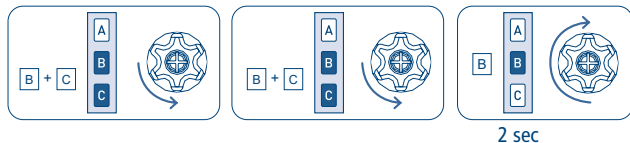

At the end of the sequence, wait until the rolling shutter is completely lowered. From this moment onwards the motor moves in "Dead Man" mode. This enables the regulation of the positions to be adjusted precisely.

Carry out the following operations:

- Raise the rolling shutter until it enters into the slat tilting zone (first click).
- Lower the rolling shutter until the slats are at their maximum opening point.
- If you wish, raise the rolling shutter until it reaches an intermediate opening of the slats (preferred opening position).
- Press button B on the remote control for 2 seconds: the rolling shutter will move in sequence to the three memorised positions: entry into the slat tilting zone, maximum opening, preferred opening.
- Raise the rolling shutter until it leaves the slat tilting zone (second click).
- Press button B on the remote control for 2 seconds: the rolling shutter will execute the entry into the slat tilting zone and will open the slats in the preferred opening position.

Functions of the remote control*

Type of Command	Outside of tilting area	In tilting area
A short (< 2 sec)	Completely raised	Less light
C short (< 2 sec)	Completely lowered	More light
A long (> 2 sec)	-	Out of tilting area Completely raised
C long (> 2 sec)	-	Out of tilting area Completely lowered
B long (> 2 sec)	Entry in tilting area	-
B short (< 2 sec)	Stops the motor	-
B long (> 4 sec)	-	Confirmation of the new preferred opening position

SLAT TILTING MECHANISM SETTING

MODE 2: Orientable roller shutter without coupling point with tilting function adjustable below the lower limit.

Only for roller shutter type Solomatic.

Not suitable for centralised control units. Not available on motors Ø 35.

After having memorized the limit switches, perform the following command sequence:

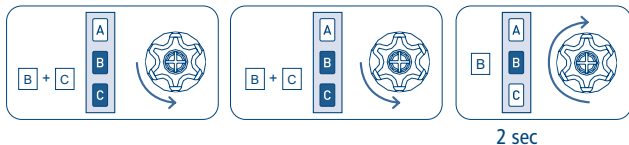

At the end of the sequence, wait until the rolling shutter is completely lowered. From this moment onwards the motor moves in "Dead Man" mode. This enables the regulation of the positions to be adjusted precisely.

Carry out the following operations:

- Lower the rolling shutter until the adjustable slats are completely opened;
- If you wish, raise the rolling shutter until it reaches an intermediate opening of the slats (preferred opening position);
- Press button B on the remote control for 2 seconds: the rolling shutter will move in sequence to the memorised positions: closed, maximum opening, preferred opening.

Functions of the remote control*

Type of Command	Outside of tilting area	In tilting area
A short (< 2 sec)	Completely raised	Less light
C short (< 2 sec)	Completely lowered	More light
A long (> 2 sec)	-	Out of tilting area Completely raised
C long (> 2 sec)	-	Out of tilting area Completely lowered
B long (> 2 sec)	Entry in tilting area	-
B short (< 2 sec)	Stops the motor	-
B long (> 2 sec)	-	Confirmation of the new preferred opening position

* see key to symbols and operational notes

SLAT OPENING MECHANISM SETTING

MODE 3: Orientable roller shutter with slats opening below the lower limit without adjustable tilting function.

Only for roller shutter type Orienta / Rollflap / Biroll / Gelosia / Girasole / Easyroll / Inklina / Estella / Luxor Noon, where the customer doesn't need to adjust the number of open slats.

Not suitable for centralised control units. Not available on motors Ø 35.

After having memorised the limit switches, perform the following command sequence:

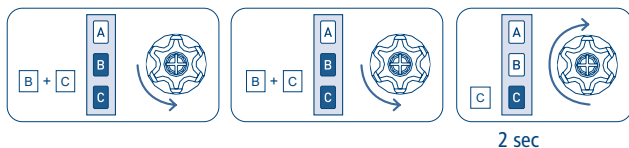

At the end of the sequence, wait until the rolling shutter is completely lowered. From this moment onwards the motor moves in "Dead Man" mode. This enables the opening positions to be adjusted precisely.

Carry out the following operations:

- Lower the rolling shutter until the adjustable slats are completely opened;
- Press button B on the remote control for 2 seconds: the rolling shutter will move in sequence to the memorised positions: closed, maximum opening.

Functions of the remote control*

Type of Command	Outside of tilting area	In tilting area
A short	Completely raised	Closure of the slats and fully raised
C short	Completely lowered	Closure of the slats and fully lowered
B long	Opening of the slats	-
B short	Stops the motor	-

* see key to symbols and operational notes

SLAT TILTING MECHANISM SETTING

(Not available on Clima RX)

MODE 4: Orientable roller shutter with coupling point for tilting function above the lower limit.

Only for roller shutter type Persyroll / Multiroll / Supergraderhermetic / Supernova.

Suitable for centralised control units.

After having memorized the limit switches, perform the following command sequence:

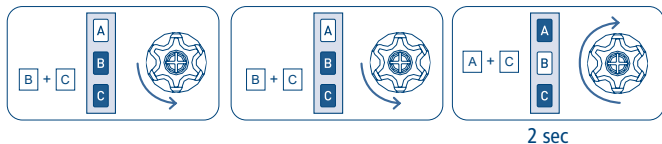

At the end of the sequence, wait until the rolling shutter is completely lowered.

From this moment onwards the motor moves in "Dead Man" mode. This enables the regulation of the positions to be adjusted precisely.

Carry out the following operations:

- Lower the rolling shutter until the adjustable slats are completely opened;
- If you wish, raise the rolling shutter until it reaches an intermediate opening of the slats (preferred opening position);
- Press button B on the remote control for 2 seconds: the rolling shutter will move in sequence to the memorised positions: closed, maximum opening, preferred opening.

Functions of the remote control*

Type of Command	Outside of tilting area	In tilting area
A short (< 2 sec)	Completely raised	Less light
C short (< 2 sec)	Completely lowered	More light
A long (> 2 sec)	Completely raised	Out of tilting area Completely raised
C long (> 2 sec)	Completely lowered	Out of tilting area Completely lowered
B short	Stops the motor	-
B long (> 2 sec)	Entry in tilting area	-
B long (> 4 sec)	-	Confirmation of the new preferred opening position

* see key to symbols and operational notes

SLAT TILTING MECHANISM SETTING

MODE 5: Orientable roller shutter without coupling point with tilting function adjustable below the lower limit.

Specific for roller shutter type Rolltek and suitable aswell for roller shutter Orienta / Rollflap / Biroll / Gelsia / Girasole / Easyroll / Inklina / Alika / Luxor Noon, if the customer wants to set the number of opening slats.

Suitable for centralised control units.

After having memorized the limit switches, perform the following command sequence:

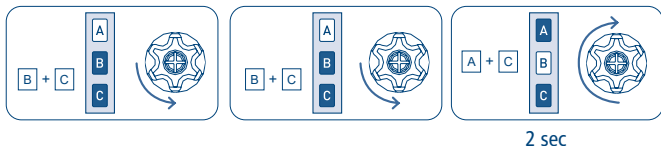

At the end of the sequence, wait until the rolling shutter is completely lowered. From this moment onwards the motor moves in "Dead Man" mode. This enables the regulation of the positions to be adjusted precisely.

Carry out the following operations:

- Lower the rolling shutter until the adjustable slats are completely opened;
- If you wish, raise the rolling shutter until it reaches an intermediate opening of the slats (preferred opening position);
- Press button B on the remote control for 2 seconds, the rolling shutter will move in sequence to the memorised positions.

Functions of the remote control*

Type of Command	Outside of tilting area	In tilting area
A short (< 2 sec)	Completely raised	Less light
C short (< 2 sec)	Completely lowered	More light
A long (> 2 sec)	Completely raised	Out of tilting area Completely raised
C long (> 2 sec)	Completely lowered	Out of tilting area Completely lowered
B short	Stops the motor	-
B long (< 2 sec)	Entry in tilting area	-
B long (> 4 sec)	-	Confirmation of the new preferred opening position

* see key to symbols and operational notes

DELETING THE TILTING FUNCTIONS

To deactivate the tilting functions, perform the command sequence:

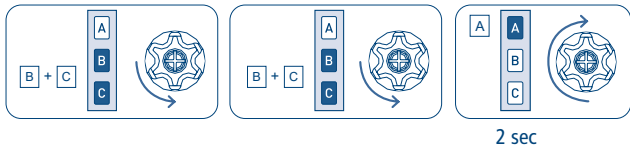

SLAT TILTING ADJUSTMENT IMPULSE

Use the following sequence to enable the slat tilting adjustment impulse with a double duration (long) compared to what it's normally set in the factory (short):

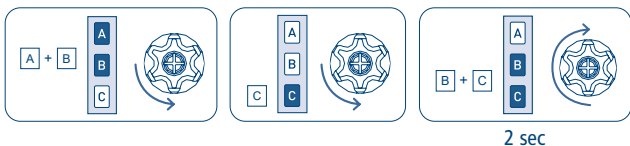

in this way fewer impulses will be needed to adjust the opening of the slats from their minimum to their maximum.

Use the following sequence to reset the duration of the slat tilting adjustment impulse set in the factory (short):

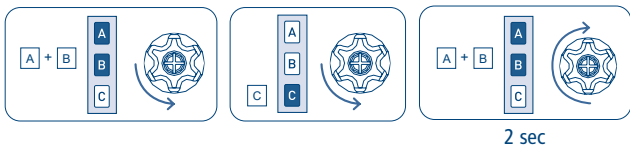

The total deletion of the limit switches automatically resets the short slat tilting adjustment impulse.

NOTES FOR THE CONTEMPORANEOUS USE OF THE MIDDLE POSITION AND THE TILTING / ORIENTATION FUNCTIONS

In the sections above, situations were discussed in which either only the tilting / orientation function or only the middle position function were to be used. If only one of the functions has been programmed the commands for its use are the same (long B from the UP/DOWN on the remote control, or UP/DOWN on the button panel).

When both tilting / orientation functions and the middle position functions have been programmed, the commands for using them change as follows:

- Reaching the middle position: use long-B (2 seconds) on the remote control.
- Entering tilting / orientation mode: on the remote control type SKIPPER and type POP press A+C, while on remote control type GIRO execute the sequence STOP short (<2s) + STOP long (2s).

ONLY MODE 1-2-3

MOVEMENT TO THE MIDDLE POSITION:

Execute the sequence UP short (< 0,5 s) - DOWN short (< 0,5 s).

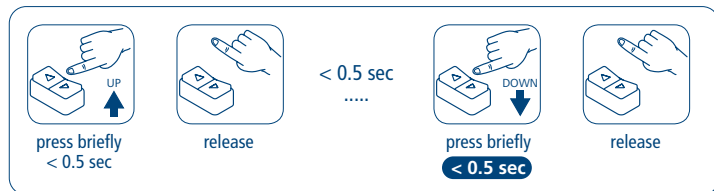

ENTRY IN TILTING AREA / OPENING SLATS:

Execute the sequence UP short (< 0,5 s) - DOWN long (> 1 s).

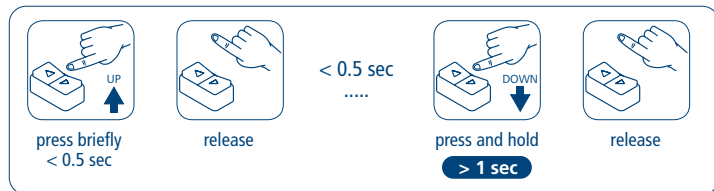

For MODE 4 see page 77.

For MODE 5 see page 78.

MOTOR PROGRAMMING FROM THE WHITE WIRE

KEY TO SYMBOLS



Press the
UP-button



Press the
DOWN-button

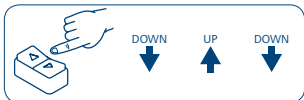
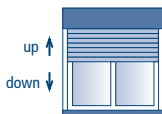

Press the buttons quickly according to the sequence indicated

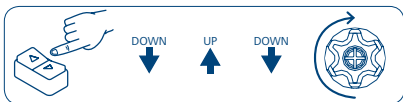

Press the buttons quickly according to the sequence indicated.
The motor will carry out a movement to confirm your settings.



short motor
rotation in one
direction



long motor
rotation in
other direction

COMMAND SEQUENCES EXAMPLE

Most of the command sequences have three or six distinct steps, at the end of which the motor indicates if the step has been concluded positively or not, by turning in different ways. This section is provided to demonstrate the motor indications. The buttons must be pressed for at least 0,5 seconds as shown in the sequence, without taking more than 1 second between one step and the next. If more than 1 second is taken, the command is not accepted and the sequence must be repeated.

Command sequence example:

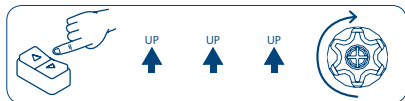

As we can see from the example, when the sequence ends positively, the motor carries out one long rotation.

If the motor does not carry out any rotation, this means that the sequence has failed. In this case the sequence must be carried out again from the start.

Attention! If the sequence requires a repetition of the same commands (Up+Up/Down+Down), an interposition of the Stop position could be necessary depending on the type of switch in use.

MOTOR PROGRAMMING FROM THE WHITE WIRE

PLEASE NOTE. If the motor is programmed from the white wire without first having memorised at least one remote control, the remote function will be deactivated automatically (to reactivate it, see page 45 - ACTIVATION/DEACTIVATION OF THE REMOTE CONTROL MOTOR FUNCTION).

Motor programming from the white wire is active until the limit switches have been programmed. Once the limit switches have been programmed, the possibility of programming the motor from the white wire remains enabled for a maximum time of 5 minutes; this to enable the changing of certain functions such as the adjustment of the closing force, the middle position, etc.

Each time that the motor power supply is disconnected and the motor is then powered up again, the programming function from the white wire is reactivated (always with a maximum duration of 5 minutes).

ADJUSTMENT OF THE LIMIT SWITCHES

During adjustment the motor will advance with a short movement and then a pause followed by a continuous movement in the desired direction.

The limit switch adjustments may be made in different ways depending on the locking devices fitted onto the shutter (spring and plug anti-intrusion locks) and the type of installation (factory installed or job-site installation).

After having programmed both the limit switches, a complete up/down cycle must be run, to enable the motor to properly associate the ascent and descent directions. During this procedure, the motor might stop briefly, to then start up again automatically. It is not allowed to memorise a middle position nor any of tilting setting (Mode 1-2-3-4-5) until the motor has completed this procedure.

SETTING IN MODE 1 (manual)

In this mode it doesn't matter whether or not the rolling shutter has got physical stops in the opening position and the lockdown hangers in the closing position. It is possible to choose whether to set the upper limit or the lower limit first.

The correct rotation direction will only be identified after the first position is set so it is sometimes necessary to use the "up" or "down" button.

EXAMPLE N.1**Setting first the opening position****SETTING THE OPENING POSITION**

If the rolling shutter is completely open, you have first to drive it down by around 20 cm.

Bring the rolling shutter to the opening position using the UP or DOWN button. (Open position)

With physical stops: press UP or DOWN button until the motor stops automatically.

Without physical stops: use the UP or DOWN button to drive the rolling shutter to the necessary opening position.

Follow the command sequence given in order to save the opening position. At the end of the sequence, the motor carries out a short "down" movement which confirms that the settings have been saved.

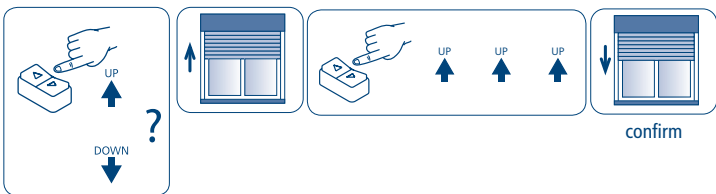
**SETTING THE CLOSING POSITION**

Pressing now the DOWN button, drive completely down the rolling shutter to the closing position.

With lockdown hangers: press the DOWN button until the motor stops automatically.

Without lockdown hangers: use UP or DOWN button to drive the rolling shutter to the necessary closing position.

Follow the command sequence given in order to save the closing position. At the end of the sequence, the motor carries out a short "up" movement which confirms that the settings have been saved.

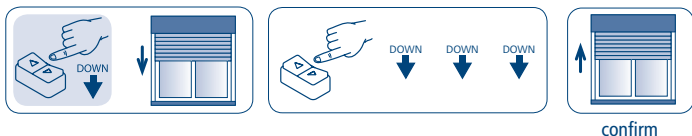

EXAMPLE N.2

Setting first the closing position

SETTING THE CLOSING POSITION

If the rolling shutter is completely closed, you have first to drive it up by around 20 cm.

Bring the rolling shutter to the closing position using the UP or DOWN button. (Closed position)

With lockdown hangers: press UP or DOWN button until the motor stops automatically.

Without lockdown hangers: use the UP or DOWN button to drive the rolling shutter to the necessary closing position.

Follow the command sequence given in order to save the closing position. At the end of the sequence, the motor carries out a short "up" movement which confirms that the settings have been saved.

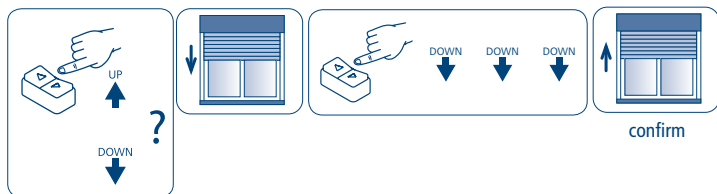

SETTING THE OPENING POSITION

Pressing now the UP button, drive completely up the rolling shutter to the open position.

With physical stops: press the UP button until the motor stops automatically.

Without physical stops: use UP or DOWN button to drive the rolling shutter to the necessary opening position.

Follow the command sequence given in order to save the opening position. At the end of the sequence, the motor carries out a short "down" movement which confirms that the settings have been saved.

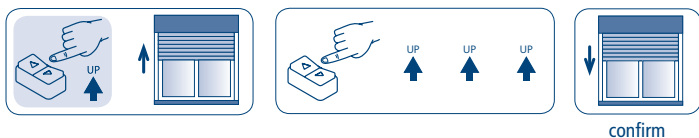

MODE 2: LIMIT SWITCH SETTING (semi-automatic)

To do the settings in this mode the rolling shutter has to be equipped with lockdown hangers in the closing position, but the rolling shutter does not need to have physical stops in the opening position. This mode of setting is helpful in cases where the factory will set the opening position and the closing position will be set automatically during the normal use.

In this mode, it's necessary to set first the opening position!! (Rolling shutter open!)

SETTING THE OPENING POSITION

If the shutter is already completely open, you have first to drive it down by about 20 cm.

Bring the rolling shutter to the opening position using the UP or DOWN button. (Open position)

With physical stops: press UP or DOWN button until the motor stops automatically.

Without physical stops: use the UP or DOWN button to drive the rolling shutter to the necessary opening position.

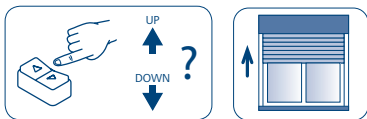

Follow the command sequence given in order to save the opening position. At the end of the sequence, the motor carries out a short "down" movement which confirms that the settings have been saved and then it brings back the shutter to the opening position.

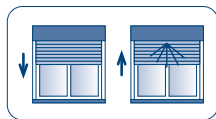
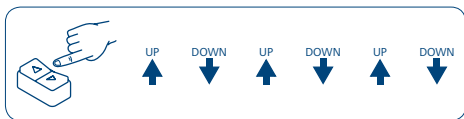

confirm

Now the drive direction is detected and the motor can be disconnected from the power. The closing position will be set automatically during the normal use.

The lower limit switch position will be set automatically the first time the rolling shutter stops automatically in the closing position using the lock down hangers. As the motor looks for a "mechanical" stop during each way down, if the Obstacle Recognition finds something is blocking the way (such as a protruding screw in the guide rails), it is necessary to raise the shutter again, remove the obstacle and to drive the motor back to the closing position to set the limit.

SETTING/DELETING A MIDDLE POSITION

MOVEMENT TO MIDDLE POSITION

From the OPENING position

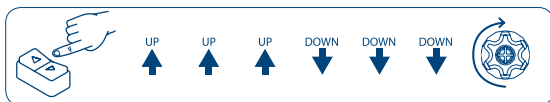

From the CLOSING position

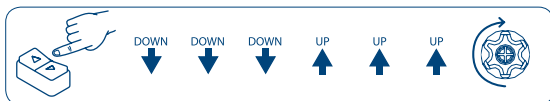

After the sequence the motor will go into "Dead Man" mode so as to enable the exact adjustment of the middle position desired. To memorise the position chosen, confirm with this sequence:

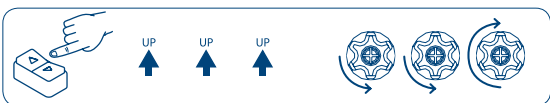

MOVEMENT TO MIDDLE POSITION

(Only if the slot tilting movement is not set, or in MODE 4, or in MODE 5)

From white wire it's possible to control the motor in the middle position: press UP very long (>2s).

For other MODES see page 65.

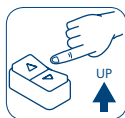

DELETING THE MIDDLE POSITION

Use one of the sequences shown here. The motor will confirm with 3 final movements that the middle position has been cancelled.

From the OPENING position

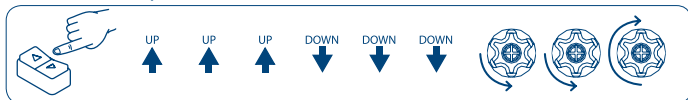

From the CLOSING position

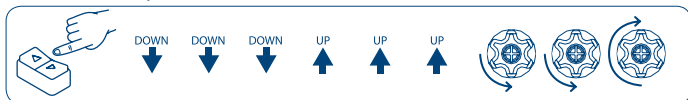

CLOSING FORCE ADJUSTMENT

This system is the only one of its kind and it guarantees that rolling shutters (which are equipped with lockdown hangers) remain perfectly closed without any danger of the slats suffering excessive pressure. The system works in all kinds of applications because of the opportunity of manually adjusting the closing force.

The motor is factory set to a closing force of 20 % of the nominal torque. This force can be changed very easily using the up-down button. It can be reduced by 10 % or increased up to 40 %, depending on the desired result.

From the OPENING position

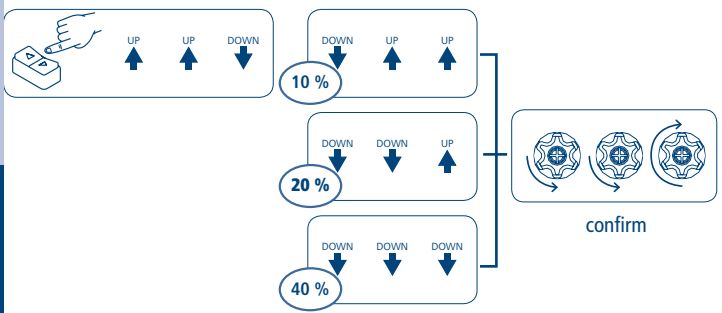

From the CLOSING position

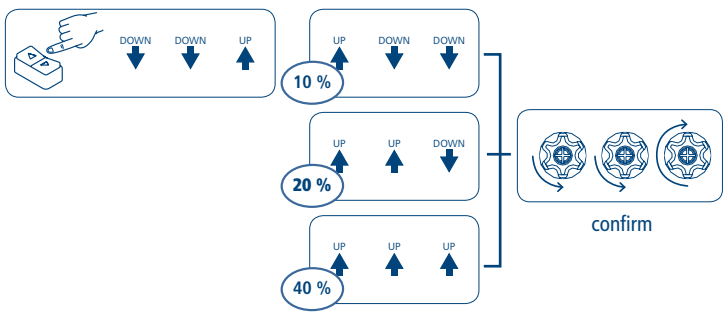

DELETING THE OPENING AND CLOSING LIMIT SWITCH

From the OPENING position

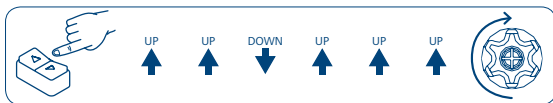

From the CLOSING position

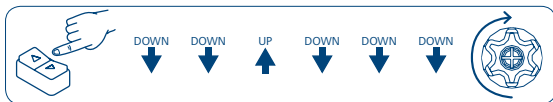

After deletion of the limit switches the radio function automatically resets.

SPECIAL FUNCTIONS

SLAT TILTING OR SLAT OPENING MECHANISM SETTING

OPERATIONAL NOTES

- MODE 1-2-3:

What is meant by a *short command* to the button (UP, DOWN) is the pressure on the button for less than 2 sec.

What is meant by a *long command* to the button (UP, DOWN) is the pressure on the button for more than 2 sec.

- MODE 4-5:

What is meant by a *short command* to the button (UP, DOWN) is the pressure on the button for less than 1 sec.

What is meant by a *long command* to the button (UP, DOWN) is the pressure on the button for more than 1 sec.

What is meant by a *very long command* to the button (UP, DOWN) is the pressure on the button for more than 2 sec.

- During the slat tilting movement, the adjustment of the opening of the slats is limited to the minimum and the maximum of their opening.
- To use the tilting / orientation function and the middle position function contemporaneously see the note on page 65.
- When one wishes to execute a long command, the motor also executes a short command.
- To stop the rolling shutter during movement, press one button of the panel buttons.

SLAT TILTING MECHANISM SETTING

(Not available on Clima RX)

MODE 1: Orientable roller shutter with coupling point for tilting function above the lower limit.

Only for roller shutter type Persyroll / Multiroll / Supergradhermetic / Supernova.
Not suitable for centralised control units. Not available on Ø 35.

After having memorised the limit switches, drive the rolling shutter to the opening position and then perform the following command sequence:

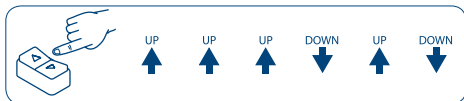

At the end of the sequence, wait until the rolling shutter is completely lowered. From this moment onwards the motor moves in "Dead Man" mode.

Carry out the following operations:

- Raise the rolling shutter until it enters into the slat tilting zone (first click).
- Lower the rolling shutter until the slats are at their maximum opening point.
- If you wish, raise the rolling shutter until it reaches an intermediate opening of the slats (preferred opening position).
- Perform the following confirmation sequence: the rolling shutter will move in sequence to the three memorised positions: entry into the slat tilting zone, maximum opening, preferred opening.
- Raise the rolling shutter until it leaves the slat tilting zone (second click).
- Perform the following confirmation sequence:



The rolling shutter will execute the entry into the slat tilting zone and will open the slats in the preferred opening position.

Functions of the button panel*

Type of Command	Outside of tilting area	In tilting area
UP short	Completely raised	Less light
DOWN short	Completely lowered	More light
UP long	Entry in tilting area	Out of tilting area Completely raised
DOWN long	Entry in tilting area	Out of tilting area Completely lowered
sequence DOWN/UP (0.5 sec)	Entry in tilting area	-
sequence UP/DOWN (0.5 sec)	Entry in tilting area	-

* see key to symbols and operational notes

SLAT TILTING MECHANISM SETTING

MODE 2: Orientable roller shutter without coupling point with tilting function adjustable below the lower limit.

Only for roller shutter type Solomatic.

Not suitable for centralised control units. Not available on motors Ø 35.

After having memorized the limit switches, drive the rolling shutter to the opening position and then perform the following command sequence:

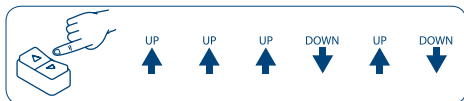

At the end of the sequence, wait until the rolling shutter is completely lowered. From this moment onwards the motor moves in "Dead Man" mode.

Carry out the following operations:

- Lower the rolling shutter until the adjustable slats are completely opened:
- If you wish, raise the rolling shutter until it reaches an intermediate opening of the slats (preferred opening position);
- Perform the following confirmation sequence:

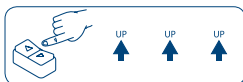

The rolling shutter will move in sequence to the memorised positions: closed, maximum opening, preferred opening.

Functions of the button panel*

Type of Command	Outside of tilting area	In tilting area
UP short	Completely raised	Less light
DOWN short	Completely lowered	More light
UP long	Entry in tilting area	Out of tilting area Completely raised
DOWN long	Entry in tilting area	Out of tilting area Completely lowered
sequence DOWN/UP (0.5 sec)	Entry in tilting area	-
sequence UP/DOWN (0.5 sec)	Entry in tilting area	-

* see key to symbols and operational notes

SLAT OPENING MECHANISM SETTING

MODE 3: Orientable roller shutter with slats opening below the lower limit without adjustable tilting function.

Only for roller shutter type / Rollflap / Biroll / Gelsia / Girasole / Easyroll / Inklina / Estella / Luxor Noon, where the customer doesn't need to adjust the number of open slats.

Not suitable for centralised control units. Not available on motors Ø 35.

After having memorised the limit switches, drive the rolling shutter to the opening position and then perform the following command sequence:

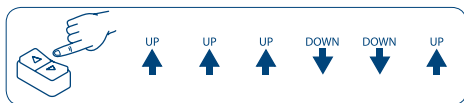

At the end of the sequence, wait until the rolling shutter is completely lowered. From this moment onwards the motor moves in "Dead Man" mode.

Carry out the following operations:

- Lower the rolling shutter until the adjustable slats are completely opened:
- Perform the following confirmation sequence:



The rolling shutter will move in sequence to the memorised positions: closed, maximum opening.

Functions of the button panel*

Type of Command	Outside of tilting area	In tilting area
Up short	Completely raised	Closure of the slats and fully raised
Down short	Completely lowered	
Up long	Opening of the slats	Closure of the slats and fully raised
Down long	Opening of the slats	Closure of the slats and fully lowered
sequence DOWN/UP (0.5 sec)	Opening of the slats	-
sequence UP/DOWN (0.5 sec)	Opening of the slats	-

* see key to symbols and operational notes

SLAT TILTING MECHANISM SETTING

(Not available on Clima RX)

MODE 4: Orientable roller shutter with coupling point for tilting function above the lower limit.

Only for roller shutter type Persyroll / Multiroll / Supergradhermetic / Supernova.
Suitable for centralised control units.

After having memorised the limit switches, drive the rolling shutter to the opening position and then perform the following command sequence:

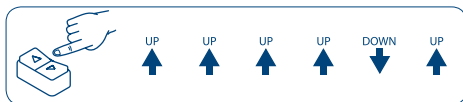

At the end of the sequence, wait until the rolling shutter is completely lowered. From this moment onwards the motor moves in "Dead Man" mode.

Carry out the following operations:

- Raise the rolling shutter until it enters into the slat tilting zone (first click).
- Lower the rolling shutter until the slats are at their maximum opening point.
- If you wish, raise the rolling shutter until it reaches an intermediate opening of the slats (preferred opening position).
- Perform the following confirmation sequence: the rolling shutter will move in sequence to the three memorised positions: entry into the slat tilting zone, maximum opening, preferred opening.
- Raise the rolling shutter until it leaves the slat tilting zone (second click).
- Perform the following confirmation sequence:



The rolling shutter will move in sequence to the memorised positions.



Functions of the button panel*

Type of Command	Outside of tilting area	In tilting area
UP short (< 1 sec)	Short movement upward	Less light
DOWN short (< 1 sec)	Short movement downward	More light
UP long (between 1 and 2 s)	Completely raised	
DOWN long (between 1 and 2 s)	Completely lowered	
UP very long (> 2 sec)	Middle position (if previously set)	
DOWN very long (> 2 sec)	Entry in tilting area	
sequence UP/DOWN or DOWN/UP fast (0.5 sec)	Middle position (if previously set) or tilting function activation	-

* see key to symbols and operational notes

SLAT TILTING MECHANISM SETTING

MODE 5: Orientable roller shutter without coupling point with tilting function adjustable below the lower limit.

Specific for roller shutter type Rolltek and suitable as well for roller shutter Orienta / Rollflap / Biroll / Gelosia / Girasole / Easyroll / Inklima / Alika / Luxor Noon, if the customer wants to set the number of opening slats. Suitable for centralised control units.

After having memorized the limit switches, drive the rolling shutter to the opening position and then perform the following command sequence:

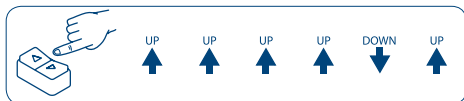

At the end of the sequence, wait until the rolling shutter is completely lowered. From this moment onwards the motor moves in "Dead Man" mode.

Carry out the following operations:

- Lower the rolling shutter until the adjustable slats are completely opened:
- If you wish, raise the rolling shutter until it reaches an intermediate opening of the slats (preferred opening position);
- Perform the following confirmation sequence:



The rolling shutter will move in sequence to the memorised positions.

Functions of the button panel*

Type of Command	Outside of tilting area	In tilting area
UP short (< 1 sec)	Short movement upward	Less light
DOWN short (< 1 sec)	Short movement downward	More light
UP long (between 1 and 2 s)	Completely raised	
DOWN long (between 1 and 2 s)	Completely lowered	
UP very long (> 2 sec)	Middle position (if previously set)	
DOWN very long (> 2 sec)	Entry in tilting area	
sequence UP/DOWN or DOWN/UP fast (0.5 sec)	Middle position (if previously set) or tilting function activation	-
DOWN short from lower limit	More light and activation of the tilting function	-

* see key to symbols and operational notes

DELETING THE TILTING FUNCTIONS

To deactivate the tilting functions, perform the command sequence:

From the OPENING position

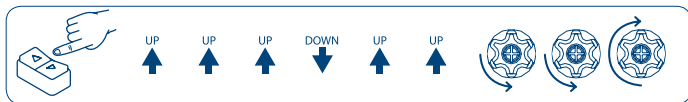

From the CLOSING position

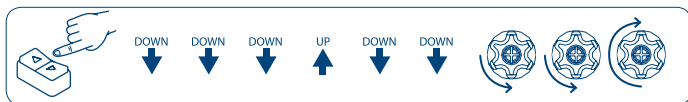

SLAT TILTING ADJUSTMENT IMPULSE

Use the following sequence to enable the slat tilting adjustment impulse with a double duration (long) compared to what it's normally set in the factory (short):

From the OPENING position

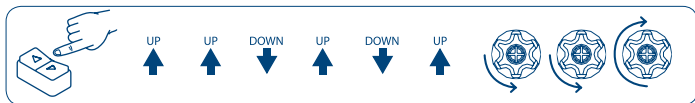

From the CLOSING position

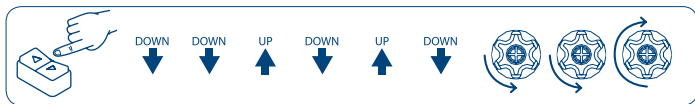

This way fewer impulses will be needed to adjust the opening of the slats from their minimum to their maximum.

Use the following sequence to reset the duration of the slat tilting adjustment impulse set in the factory (short):

From the OPENING position

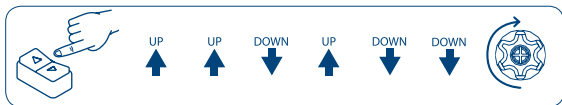

From the CLOSING position

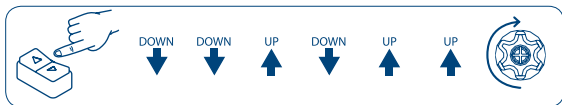

The total deletion of the limit switch automatically resets the short slat tilting adjustment impulse.

COMMAND MANAGEMENT FROM WHITE WIRE

UP-DOWN "CONTINUOUS MOVEMENT"/ UP-DOWN "DEAD MAN"

The default function provided in the motors leaving the factory is for two independent buttons "UP-DOWN Continuous Movement". It's always possible to change the type of motor control to "UP-DOWN Dead Man" mode (and viceversa), with the following sequence:

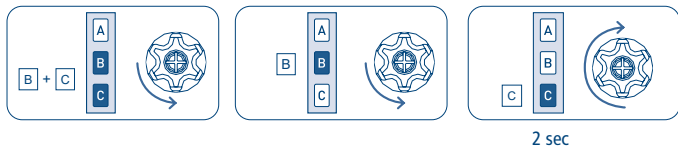

EU DECLARATION OF CONFORMITY

CE CHERUBINI S.p.A. declares that the product is in conformity with the relevant Union harmonisation legislation:

Directive 2014/53/EU, Directive 2011/65/EU.

The full text of the EU declaration of conformity is available upon request at the following website: www.cherubini.it.

CHERUBINI S.p.A.

Via Adige 55
25081 Bedizzole (BS) - Italy
Tel. +39 030 6872.039 | Fax +39 030 6872.040
info@cherubini.it | www.cherubini.it

CHERUBINI Iberia S.L.

Avda. Unión Europea 11-H
Apdo. 283 - P. I. El Castillo
03630 Sax Alicante - Spain
Tel. +34 (0) 966 967 504 | Fax +34 (0) 966 967 505
info@cherubini.es | www.cherubini.es

CHERUBINI France S.a.r.l.

ZI Du Mas Barbet
165 Impasse Ampère
30600 Vauvert - France
Tél. +33 (0) 466 77 88 58 | Fax +33 (0) 466 77 92 32
info@cherubini.fr | www.cherubini.fr

CHERUBINI Deutschland GmbH

Siemensstrasse, 40 - 53121 Bonn - Deutschland
Tel. +49 (0) 228 962 976 34 / 35 | Fax +49 (0) 228 962 976 36
info@cherubini-group.de | www.cherubini-group.de

