

## PLUG&PLAY

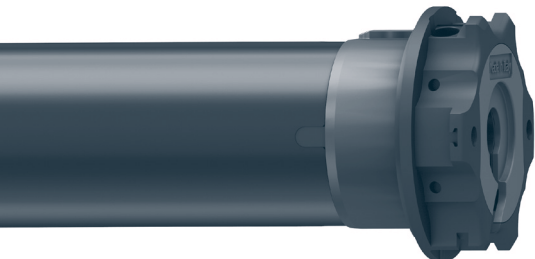

MOTORE TUBOLARE CON REGOLAZIONE AUTOMATICA  
DEL FINECORSA ELETTRONICO

**IT**

TUBULAR MOTOR WITH AUTOMATIC ADJUSTMENT  
OF THE ELECTRONIC LIMIT SWITCH

**EN**

ROHRMOTOR MIT AUTOMATISCHER EINSTELLUNG  
DER ELEKTRONISCHEN ENDLAGEN

**DE**

MOTEUR TUBULAIRE AVEC RÉGLAGE AUTOMATIQUE  
DES FINS DE COURSE ÉLECTRONIQUES

**FR**

MOTOR TUBULAR CON REGULACIÓN AUTOMÁTICA  
DEL FIN DE CARRERA ELECTRONICO

**ES**





## ELECTRICAL CONNECTIONS

- To prevent any danger or malfunction, the size of electrical control components connected to the motor must be compatible with the electrical features of the motor.
- Means for disconnection must be incorporated in the fixed wiring in accordance with the national installation standards.
- For outdoor use, provide the appliance with a supply cord with designation H05RN-F containing at least 2% of carbon.
- Cable length between motor and control-switch maximal 50 m.  
In case of cable length more than 50 m an interface-relay have to be used.

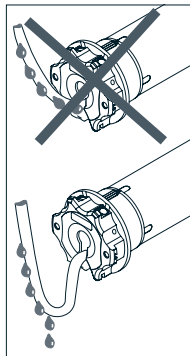
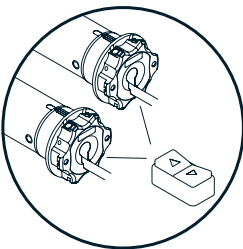
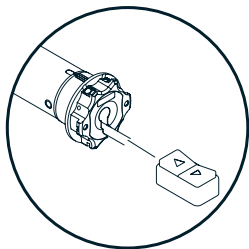
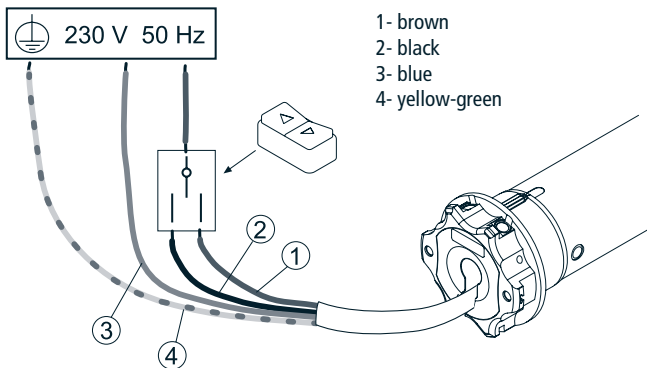

## HOW TO PREPARE THE MOTOR

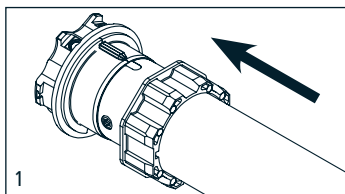
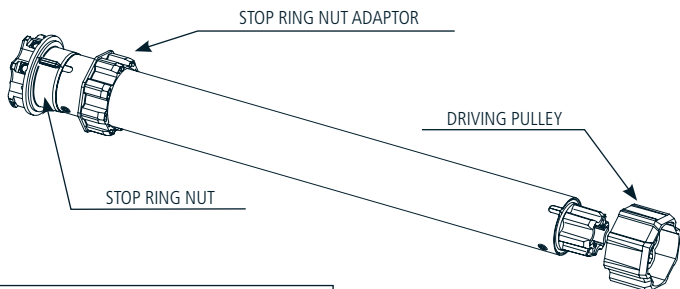

1. Insert the adaptor in the stop ring nut mating the groove with the reference notch and push till they touch.

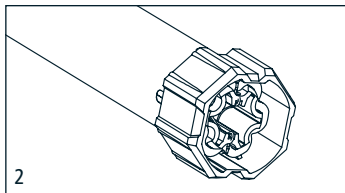

2. Fix the driving pulley on the motor pin until the stop pin clicks.

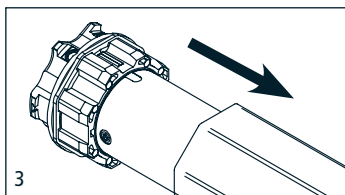

3. Insert the motor fully in the rolling tube.

**NB:** If you use tubes with a round form, the driving pulley must be fixed to the tube, and the installation is to be paid by the person who installs the system. For other tube sections the fitting is optional, but strongly recommended.

## INSTRUCTION FOR USE

The tubular motor is very simple to be used and installed, it does not need any regulation as it automatically detects the position of limit switch.

The rolling shutter must be equipped with:

A - security locks or stiff fixing springs,

B - fixed or removable stoppers for end slats.

It is very important to check the sturdiness of the rolling shutter.

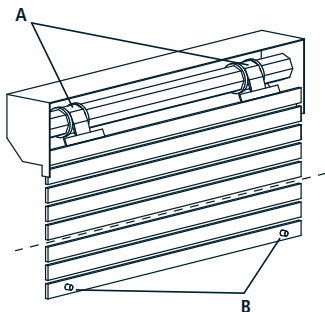

## MOTOR OPERATION

	STOP AT LIMIT SWITCH (OPENING AND CLOSING)	OBSTACLE DETECTION DURING MOVEMENT
Plug&Play	It always reaches the limit switch and then slightly reverses itself to decrease the force.	It stops and slightly reverses itself to decrease the force.

When an obstacle is detected in one direction, the movement is inhibited in that direction. Please operate the motor in the opposite direction to restore normal operation.

### EU DECLARATION OF CONFORMITY



CHERUBINI S.p.A. declares that the product is in conformity with the relevant Union harmonisation legislation:

Directive 2014/35/EU - Directive 2014/30/EU - Directive 2011/65/EU

The full text of the EU declaration of conformity is available upon request at the following website: [www.cherubini.it](http://www.cherubini.it).

## Note - Bem - Notes - Notas:

A series of 20 horizontal dotted lines for writing notes.



**CHERUBINI S.p.A.**

Via Adige 55  
25081 Bedizzole (BS) - Italy  
Tel. +39 030 6872.039 | Fax +39 030 6872.040  
info@cherubini.it | www.cherubini.it

**CHERUBINI Iberia S.L.**

Avda. Unión Europea 11-H  
Apdo. 283 - P. I. El Castillo  
03630 Sax Alicante - Spain  
Tel. +34 (0) 966 967 504 | Fax +34 (0) 966 967 505  
info@cherubini.es | www.cherubini.es

**CHERUBINI France SAS**

ZI Du Mas Barbet  
165 Impasse Ampère  
30600 Vauvert - France  
Tél. +33 (0) 466 77 88 58  
info@cherubini.fr | www.cherubini.fr

**CHERUBINI Deutschland GmbH**

Siemensstrasse, 40 - 53121 Bonn - Deutschland  
Tel. +49 (0) 228 962 976 34 / 35 | Fax +49 (0) 228 962 976 36  
info@cherubini-group.de | www.cherubini-group.de

