

# CHERUBINI

A520007 WINDTEC  
A520008 WINDTEC LUX



WIND SENSOR & SUN SENSOR

EN

CE

INSTRUCTIONS



**Table of contents**

 WARNING: Important safety instructions .....	4
Technical features.....	6
Compatibility .....	7
Electrical connections .....	7
Lux function.....	8
Key to symbols .....	9
Compatible remote controls.....	9
Command sequences example.....	10
Setting of several motors to one sensor .....	11
Where to place the sensor.....	11
Fitting the sensor.....	12
Setting the sensor .....	13
Deleting the sensor.....	13
Setting the Wind sensor.....	14
Activating automatic reopening.....	14
Deactivating automatic reopening.....	15
Setting the sun sensor.....	15
Activating the automatic or manual setting mode by the remote control series <b>GIRO</b> .....	<b>16</b>
Activating the automatic or manual setting mode by the remote control series <b>POP</b> .....	<b>17</b>
Activating the automatic or manual setting mode by the remote control series <b>SKIPPER</b> ..	<b>17</b>
Test mode .....	18
EU Declaration of conformity .....	18

These safety instructions supplement the product instructions. Please give these instructions to the final user after installation.

**⚠ WARNING: IMPORTANT SAFETY INSTRUCTIONS**

It is important for the safety of persons to follow these instructions. Keep these instructions.

**⚠ WARNING: The appliance shall be disconnected from its power source during cleaning, maintenance and when replacing parts.**

This product has been designed for the automation of external awnings on the basis of the wind speed and light intensity (WINDTEC LUX model). Any other use is improper. Special applications shall be submitted to Cherubini S.p.A.'s analysis and approval.

- Only professional technicians must perform installation, complying with all safety instructions, especially those regarding electrical connections.
- This product is not intended for use by children under 8 years of age or by persons with reduced physical, sensory or mental capabilities, or lack of experience or knowledge. Cleaning and maintenance intended to be carried out by the user must not be carried out by unsupervised children.
- Do not allow children to play with awning driving. Keep remote controls out of the reach of children.
- Awnings: do not operate the awning when maintenance, such as window cleaning, is being carried out in the vicinity.
- In applications where automatic operation is possible (e.g. timer, anemometer, home automation system), disconnect the power supply when maintenance work, such as window cleaning, is being carried out in the vicinity.
- Frequently examine the installation in order to detect any out-of-balance condition and signs of wear or damage to cables and springs. Do not use if repair or adjustment is necessary.
- The supply cable of this appliance can be replaced only by the same type of cable supplied by Cherubini S.p.A.
- The acoustic emission level of this appliance is lower than 70dB(A):  $L_p < 70\text{dB(A)}$ .
- These instructions are also available at the following internet address:
- <https://www.cherubini.it/academy/elenco-prodotti/sensore-windtec-e-windtec-lux-15>.

## WARNINGS FOR INSTALLER

 **WARNING: Important safety instructions. Follow all instructions, since incorrect installation can lead to severe injury.**

- Before installation, check the compatibility of this product with tubular motors and associated accessory devices.
- The device must be installed more than 2.5 m from the floor or other plane that could allow access.
- Adjusting devices have to be clearly visible after installation.
- The device must be protected against overloads by a circuit-breaker with a rated current not exceeding 10 A and a high-current fast-blow fuse type TO,315AH/250V.
- Before installation, remove any unnecessary cables and switch off any equipment not required for powered operation.
- Before any maintenance, installation or cleaning work, switch off the power supply.
- If the supply cable is damaged, it must be replaced by Cherubini Service in order to prevent any risk.
- If in doubt when installing the device or for more information, consult a CHERUBINI S.p.A. technician or visit the website at:
- <https://www.cherubini-group.com/en/academy/product-list/windtec-and-windtec-lux-sensor-15>

## WARNINGS FOR USER

- Do not service or repair the product: refer to competent technical personnel.
-  If the supply cable is damaged please call the assistance centre or qualified technical staff, in order to avoid any hazard.
- Do not subject the product to crushing, knocks, falls or contact with liquids of any kind; do not drill holes or apply screws.
- The warranty does not cover any damage caused by misuse, straining, tampering or incorrect connections.

## WARNINGS FOR USER

 **WARNING:** CHERUBINI S.p.A. accepts no liability for material damage caused by climatic events that cannot be detected by the wind sensor.

This sensor does not protect motorised products in the event of strong gusts of wind. The maximum wind speed detectable by the sensor is 45 km/h.



In the event of strong gusts of wind, please ensure that the awning is fully retracted.

## TECHNICAL FEATURES

There are two versions of the WindTec sensor:

WindTec: Wind sensor

WindTec Lux: Wind & Sun sensor.

	<b>WINDTEC WIND</b> 	<b>WINDTEC LUX WIND &amp; SUN</b> 
Power supply (V / Hz)	230 / 50	230 / 50
Radio frequency (MHz)	433,92	433,92
Wind sensor setting (km/h)	7,5 - 45	7,5 - 45
Maximum RF power transmitted	4 mW (5,6 dBm)	4 mW (5,6 dBm)
Rated impulse voltage (kV)	2,5	2,5
Sun sensor setting (klux)		2,5 - 100
Protection degree	IP34	IP34
Dimensions (mm)	300x140xH95	300x140xH95
Weight	365	365
Operating temperature	-10° +40° C	-10° +40° C
Storage temperature	-25° +40° C	-25° +40° C
Altitude max	2.000 m	2.000 m

## COMPATIBILITY

According to the motor / control unit to which the WindTec is associated, the availability of certain features changes as indicated in the following table:

	CLOSING BY WIND ALARM	AUTOMATIC REOPENING	OPENING AND CLOSING WITH LIGHT*	ADDITIONAL MIDDLE POSITION*	"PRIVACY" POSITION*
WAVE RX / SENSO RX	√	√	√	√	
ORA ZRX / REBIS ZRX	√	√	√	√	
ORA WRX	√	√	√	√	
GARDA RX / OCEAN RX	√	√	√	√	
Radio receiver TDS CMPACT	√		√	√	
Radio receiver TDS GOLD	√		√		
Radio receiver MINI/MYROLL	√		√		
Radio receiver ORIENS CRC	√		√		√

\* only for Lux version

## ELECTRICAL CONNECTIONS

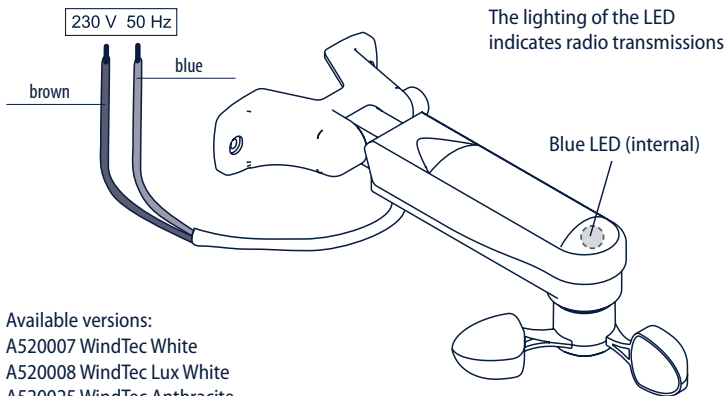

Available versions:

A520007 WindTec White

A520008 WindTec Lux White

A520025 WindTec Anthracite

A520026 WindTec Lux Anthracite

## LUX FUNCTION

**ATTENTION!** The light function in model "WindTec Lux" can be activated only by using a remote control series SKIPPER, GIRO or POP with the LUX function (Skipper Lux / Skipper P-Lux, Giro Lux / Giro P-Lux or POP Lux / POP P-Lux).

### SKIPPER Series

SKIPPER LUX  
SKIPPER P-LUX

Activating/ Deactivating the Sun sensor

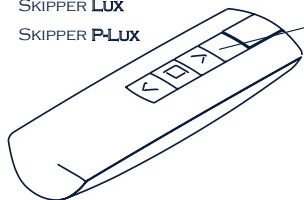

Wind & Sun sensor activated



Only Wind sensor activated

### GIRO Series

GIRO Lux

Activating the Sun sensor

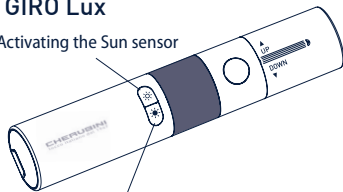

Deactivating the Sun sensor



Wind & Sun sensor activated

GIRO P-Lux

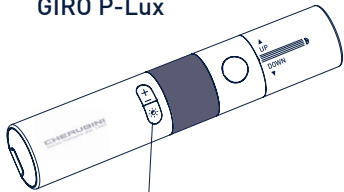

Activating/ Deactivating the Sun sensor



Only Wind sensor activated

### POP Series

POP Lux  
POP P-Lux

Activating/ Deactivating the Sun sensor

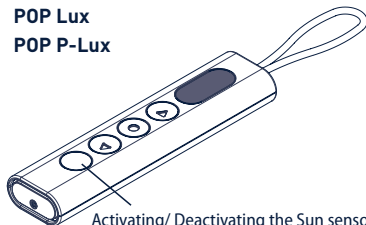

Wind & Sun sensor activated



Only Wind sensor activated

## COMPATIBLE REMOTE CONTROLS

## GIRO

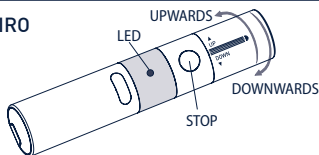

## GIRO Wall

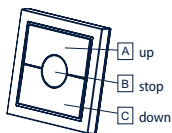

## GIRO Plus

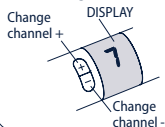

## GIRO Lux

Activating the Sun sensor

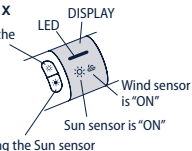

## GIRO P-Lux

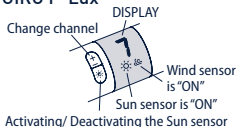

## POP

## POP Lux

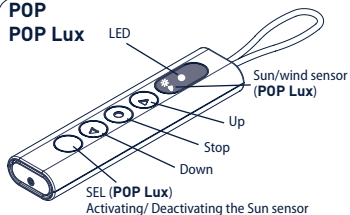

## POP Plus

## POP P-Lux

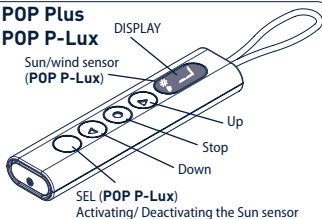

SKIPPER  
SKIPPER Lux  
SKIPPER PLUS  
SKIPPER P-Lux

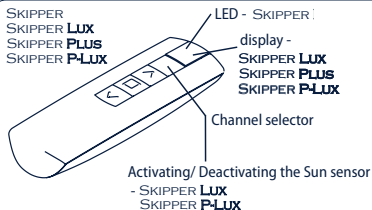

SKIPPER LCD  
SKIPPER SENSO

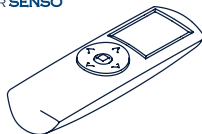

Check the specific instruction book

## KEY TO SYMBOLS

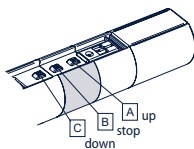

## GIRO

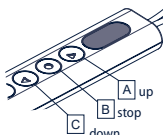

## POP

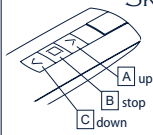

## SKIPPER

## Key to symbols

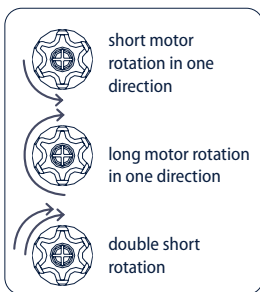
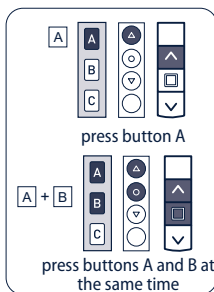
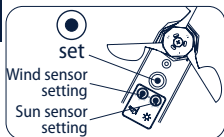
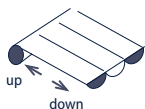

## COMMAND SEQUENCES EXAMPLE

Most of the command sequences have three distinct steps, at the end of which the motor indicates if the step has been concluded positively or not, by turning in different ways. The buttons must be pressed as shown in the sequence, without taking more than 4 seconds between one step and the next. If more than 4 seconds are taken, the command is not accepted and the sequence must be repeated. Command sequence example:

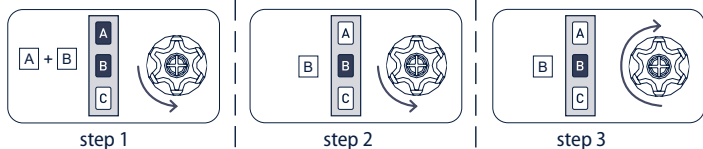

As we can see from the example, when the sequence ends positively, the motor returns to its starting position in one long rotation. In fact, two short rotations in the same direction correspond to one long rotation in the opposite direction. The motor returns to the starting position even when the sequence is not completed; in this case by performing one or two short rotations. Example of a wrong sequence:

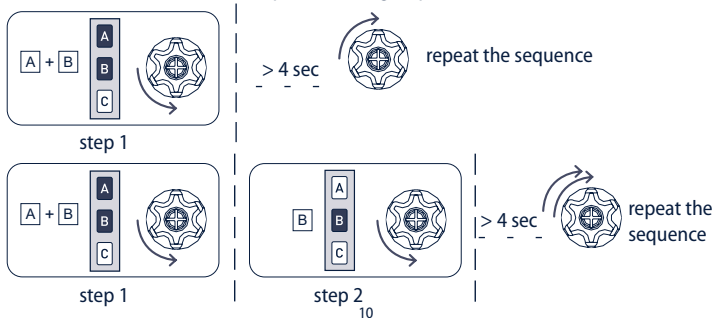

## ATTENTION! WHERE TO PLACE THE SENSOR

The WindTec sensor must be positioned to the side, as close as possible to its awning, and not above or below the awning coverage area.

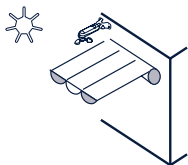

RIGHT

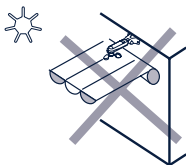

WRONG

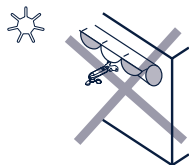

WRONG

## SETTING OF SEVERAL MOTORS TO ONE SENSOR

One single WindTec sensor can be used to automate a group of motorised awnings. For a correct function, the coupled awnings must be mounted and exposed to sunlight and wind in the same way. Do not connect more than 5 motors to one wind sensor.

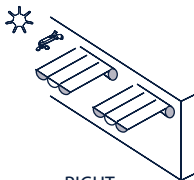

RIGHT

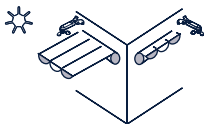

RIGHT

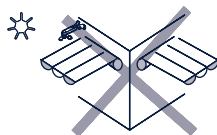

WRONG

**CAUTION:** In order to avoid 'overcrowding' of radio transmissions, resulting in malfunctioning of the sensors and other radio equipment themselves, it is necessary to minimise the density of installed sensors by associating several motors/control unit with the same sensor, bearing in mind that each sensor can work effectively within a range of 10 to 15 metres, and that a maximum of 5 sensors may be installed within the same 10 to 15 metre range.

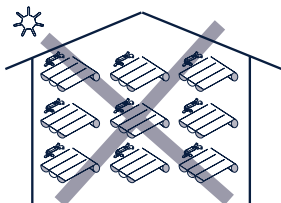

NO

## FITTING THE SENSOR

The WindTec sensor has a positioning mechanism for fitting to any surface. To adjust the angle of the support, press the button located at the pivot point (see drawing).

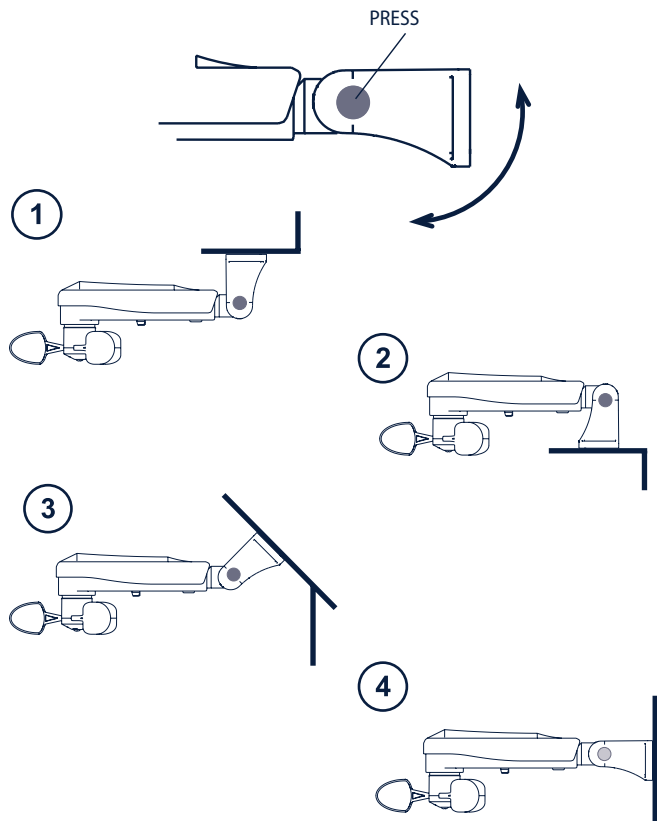

## SETTING THE SENSOR

To associate the sensor to a motor, a remote control must be already memorised on the motor. The setting sequence is the following:

Tn: Already programmed remote control

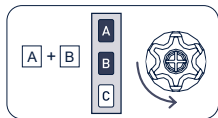

Tn

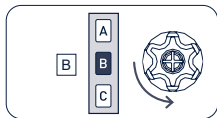

Tn



2 sec

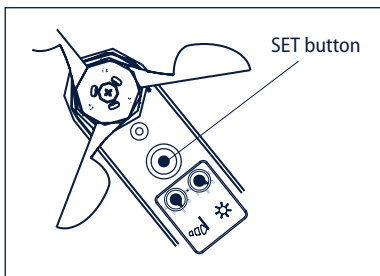

## DELETING THE SENSOR

To delete the sensor from the motor, an already programmed remote control must be used. The deleting sequence is the following:

Tn: Already programmed remote control

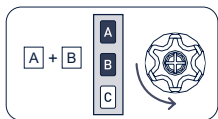

Tn

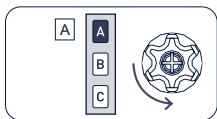

Tn



2 sec

## SETTING THE WIND SENSOR

The wind level point can be set using the button provided in the lower part of the WindTec sensor, identified by the windsock symbol. The speed can be set from a minimum of 7,5 Km/h to a maximum of 45 Km/h.



It's prudent not to set the wind speed over the fourth level, which corresponds to 35 Km/h.

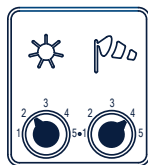
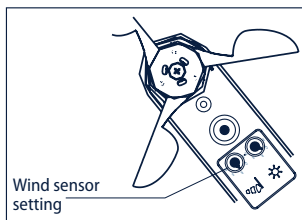

MAXIMUM RECOMMENDED SPEED FOR THE WIND-ALARM (35 km/h)

Following a wind alarm, the motor closes automatically the awning, overriding user commands until the wind alarm passes. To deactivate the wind alarm, it's necessary that the wind speed remains below the set level for at least 8 minutes. After these 8 minutes the awning returns to the position it was in before the alarm, if the automatic reopening function is active. This pause time is included to ensure awning protection and to prevent continuous motor movement in the event of sporadic gusts of wind.

## ACTIVATING AUTOMATIC REOPENING

**- only with WAVE RX / SENSO RX / ORA ZRX / REBIS ZRX / ORA WRX motors -**

With the automatic reopening system, at the end of the wind alarm, the awning opens again. The motor is factory programmed with automatic reopening function disabled. The function can be activated at any time with the following command sequence:

Tn: Already programmed remote control

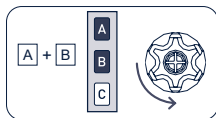

Tn

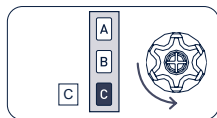

Tn

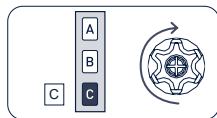

Tn (2 sec)

## DEACTIVATING AUTOMATIC REOPENING

- only with WAVE RX / SENSO RX / ORA ZRX / REBIS ZRX / ORA WRX motors -

The automatic reopening function can be deactivated at any moment with the following command sequence:

Tn: Already programmed remote control

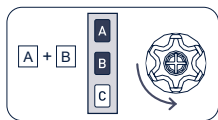

Tn

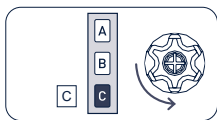

Tn

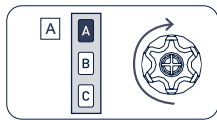

Tn (2 sec)

## SETTING THE SUN SENSOR (WindTec Lux)

The light level point can be set using the button provided in the lower part of the WindTec Lux sensor, identified by the sun symbol.



The light intensity can be set from a minimum of 2.5 kLux (dawn light) up to a maximum of 100 kLux (midday sunlight). To activate the automatic awning opening, the light intensity must exceed the set level for 1 minute, while for automatic closing, the light intensity must remain below the set level for at least 10 minutes. These pause times are included to prevent the motor from moving continuously in the event of passing clouds. Automatic opening and closing only work when the motor is set to the automatic wind + light mode.

## ACTIVATING THE AUTOMATIC OR MANUAL SETTING MODE BY THE REMOTE CONTROL SERIES GIRO

The manual mode (wind only), or automatic mode (wind + sun) setting has to be done by the Giro Lux or Giro P-Lux remote control.



Wind & Sun sensor activated



only Wind sensor activated

Using the front buttons on the remote control do the following:

### GIRO Lux

By pressing briefly one button the display will show the current setting.



Activating

Deactivating

To change setting, press for at least 3 seconds the button related to the desired function, till the motor feedback.



(3 sec)



### GIRO P-Lux

By pressing briefly the button the display will show the current setting.



Activating/ Deactivating

To change setting press the same button for at least 3 seconds till the motor feedback.



(3 sec)



## ACTIVATING THE AUTOMATIC OR MANUAL SETTING MODE BY THE REMOTE CONTROL SERIES POP

The manual mode (wind only), or automatic mode (wind + sun) setting has to be done by the POP Lux or POP P-Lux remote control.



Wind & Sun sensor activated



only Wind sensor activated

By briefly pressing the “SEL” button, the remote control shows the current setting. To change the setting press the SEL button again and hold it down for around 2 sec, until the motor replies with a confirmation sequence.

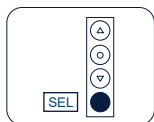

Tn

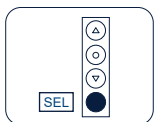

Tn (2 sec)



## ACTIVATING THE AUTOMATIC OR MANUAL SETTING MODE BY THE REMOTE CONTROL SERIES SKIPPER

The manual mode (wind only), or automatic mode (wind + sun) setting has to be done by the Skipper Lux or Skipper P-Lux remote control.



Wind & Sun sensor activated



only Wind sensor activated

By briefly pressing the “SEL” button, the remote control shows the current setting. To change the setting press the SEL button again and hold it down for around 2 sec, until the motor replies with a confirmation sequence.



Tn

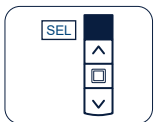

Tn (2 sec)



## TEST MODE

This function is useful to check the correct communication via radio, and to perform the wind and sun function test.

To activate the TEST function, hold the SET button down for around 2 seconds, until the motor confirms the command by bringing the awning to half opening distance. The test function lasts for 3 minutes, during which the wind and light level settings can be checked, without waiting for the activation times. After 3 minutes, the WindTec sensor returns to normal mode function.

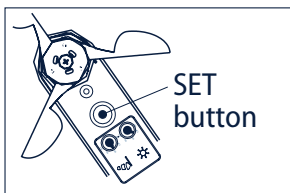

(2 sec)

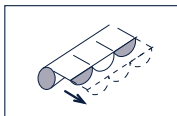

### WIND FUNCTION TEST

To avoid errors during the wind function test, we advise setting the motor to manual mode (wind only). With the anemometer blades moving, when the speed detected by the sensor exceeds the set level, the motor will close completely the awning. After the awning is closed and the anemometer blades stop turning, the awning returns to halfway out if the automatic reopening function is active. If the automatic reopening function is not active, the awning remains closed.

### SUN FUNCTION TEST (WindTec Lux)

Check that the motor is set to automatic mode. When the sensor detects a change in light intensity, it opens the awning if brighter than the set point or closes it if weaker. This test can be repeated several times to establish the desired automatic opening and closing level according to the light.

## EU DECLARATION OF CONFORMITY



The Manufacturer CHERUBINI S.p.A. declares that the radio equipment type WindTec and WindTec Lux are in conformity with the Directive 2014/53/EU.

The full text of the EU declaration of conformity is available at:

<https://www.cherubini-group.com/en/academy/product-list/windtec-and-windtec-lux-sensor-15>





**CHERUBINI S.p.A.**

Via Adige 55  
25081 Bedizzole (BS) - Italy  
Tel. +39 030 6872.039  
info@cherubini.it | www.cherubini.it

**CHERUBINI Iberia S.L.**

Avda. Unión Europea 11-H  
Apdo. 283 - P. I. El Castillo  
03630 Sax Alicante - Spain  
Tel. +34 (0) 966 967 504  
info@cherubini.es | www.cherubini.es

**CHERUBINI France SAS**

ZI Du Mas Barbet  
165 Impasse Ampère  
30600 Vauvert - France  
Tél. +33 (0) 466 77 88 58  
info@cherubini.fr | www.cherubini.fr

**CHERUBINI Deutschland GmbH**

Rotter Viehtrift 4A - 53842 Troisdorf - Deutschland  
Tel. +49 (0) 224 126 699 74 | Fax +49 (0) 224 126 699 73  
info@cherubini-group.de | www.cherubini-group.de